

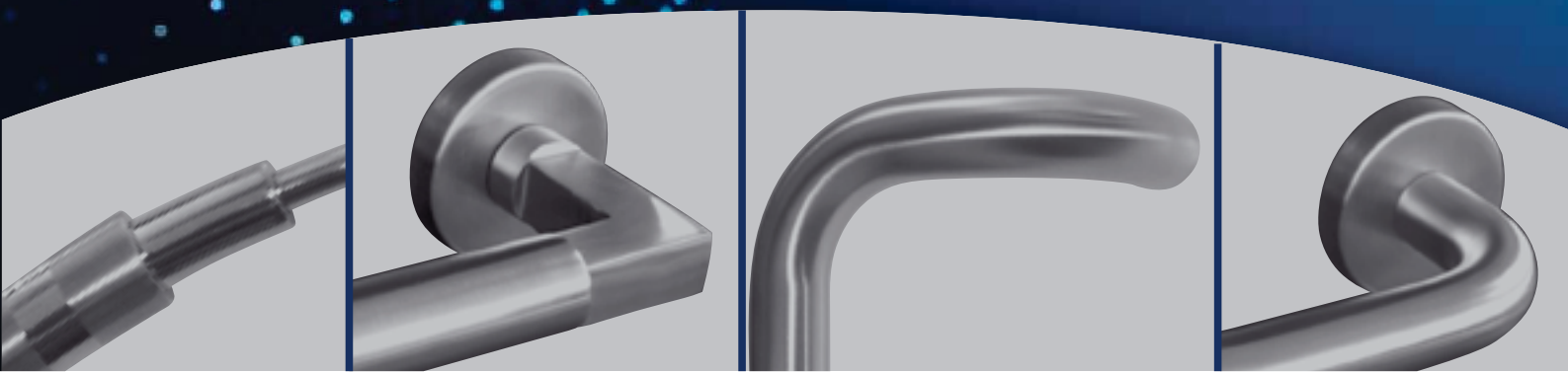

CATALOGO GENERALE  
GENERAL CATALOGUE



Ecoproject è un nuovo brand creato appositamente per la distribuzione di prodotti in acciaio inox di qualità a prezzi concorrenziali.

Maniglie, maniglioni e accessori per porte e finestre sono i prodotti target di EcoProject®.

La qualità è garantita da un controllo accurato eseguito dal nostro personale specializzato prima di ogni fornitura.

Una vasta gamma di prodotti dal design italiano, in pronta consegna.

*EcoProject® è un brand esclusivo di MPM srl® per la distribuzione in Italia, Europa e Resto del Mondo.*

EcoProject is a new brand created for the distribution of quality products in stainless steel at competitive prices.

Handles, pull handles and accessories for doors and windows are EcoProject's target products.

The quality is guaranteed thanks to the accurate control realized by our specialized staff to which every single item is submitted before sale.

A large range of products with italian design, in prompt delivery.

*EcoProject® is an exclusive brand of MPM srl® for the distribution in Italy, Europe and All around the World.*

## **INDICE / INDEX**

<b>PROGETTO 05 ECO MANIGLIONI INOX</b> .....	02
<b>PROGETTO 06 ECO MANIGLIE INOX</b> .....	30
<b>PROGETTO 06 ECO POMOLI INOX</b> .....	54
<b>PROGETTO 06 ECO MANIGLIONI PER ALZANTI SCORREVOLI</b> ...	59
<b>MODULI OFFERTA / ORDINI</b> .....	63

Cod. 05.01-ECO

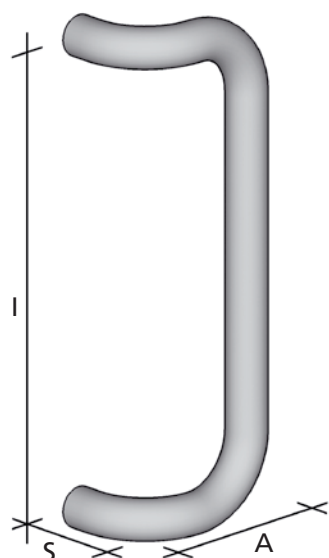

COD.	Ø	I	A	S	PACK
05.01.305-ECO	32	350	145	85	2

FINITURA STANDARD: SATINATO  
STANDARD FINISHING: SATIN

FINITURA A RICHIESTA: VEDI LEGENDA  
FINISHING ON REQUEST: SEE LEGEND

Cod. **05.02-ECO**

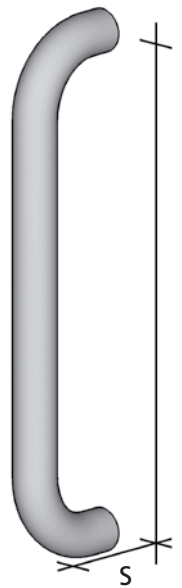

<b>COD.</b>	<b>Ø</b>	<b>I</b>	<b>S</b>	<b>PACK</b>
<b>05.02.102-ECO</b>	20	200	67	2
<b>05.02.305-ECO</b>	32	350	85	2

FINITURA STANDARD: SATINATO  
STANDARD FINISHING: SATIN

FINITURA A RICHIESTA: VEDI LEGENDA  
FINISHING ON REQUEST: SEE LEGEND

# PROGETTO 05 ECO INOX AISI 304

PROJECT 05 ECO STAINLESS STEEL AISI 304

Cod. 05.15-ECO

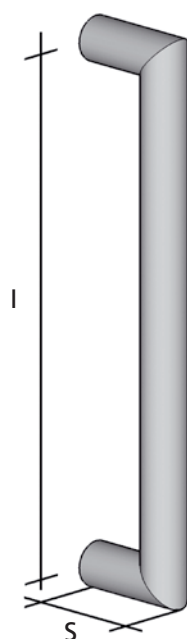



COD.	Ø	I	S	PACK
05.15.101-ECO	20	200	65	2
05.15.301-ECO	32	350	75	2

FINITURA STANDARD: SATINATO  
STANDARD FINISHING: SATIN

FINITURA A RICHIESTA: VEDI LEGENDA  
FINISHING ON REQUEST: SEE LEGEND

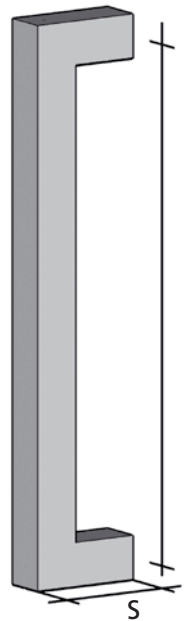
Cod. **05.24-ECO**



<b>COD.</b>		<b>I</b>	<b>S</b>	<b>PACK</b>
<b>05.24.101-ECO</b>	20 x 20	200	65	2
<b>05.24.301-ECO</b>	30 x 30	350	75	2

FINITURA STANDARD: SATINATO  
STANDARD FINISHING: SATIN

FINITURA A RICHIESTA: VEDI LEGENDA  
FINISHING ON REQUEST: SEE LEGEND

# PROGETTO 05 ECO INOX AISI 304

PROJECT 05 ECO STAINLESS STEEL AISI 304

Cod. 05.12-ECO



COD.		I	S	PACK
05.12.511-ECO	40 x 20	350	65	2

FINITURA STANDARD: SATINATO  
STANDARD FINISHING: SATIN

FINITURA A RICHIESTA: VEDI LEGENDA  
FINISHING ON REQUEST: SEE LEGEND



Cod. **05.03-ECO**



<b>COD.</b>	<b>Ø</b>	<b>I</b>	<b>A</b>	<b>S</b>	<b>PACK</b>
<b>05.03.302-ECO</b>	32	350	180	85	2

FINITURA STANDARD: SATINATO  
STANDARD FINISHING: SATIN

FINITURA A RICHIESTA: VEDI LEGENDA  
FINISHING ON REQUEST: SEE LEGEND



Cod. **05.13-ECO**

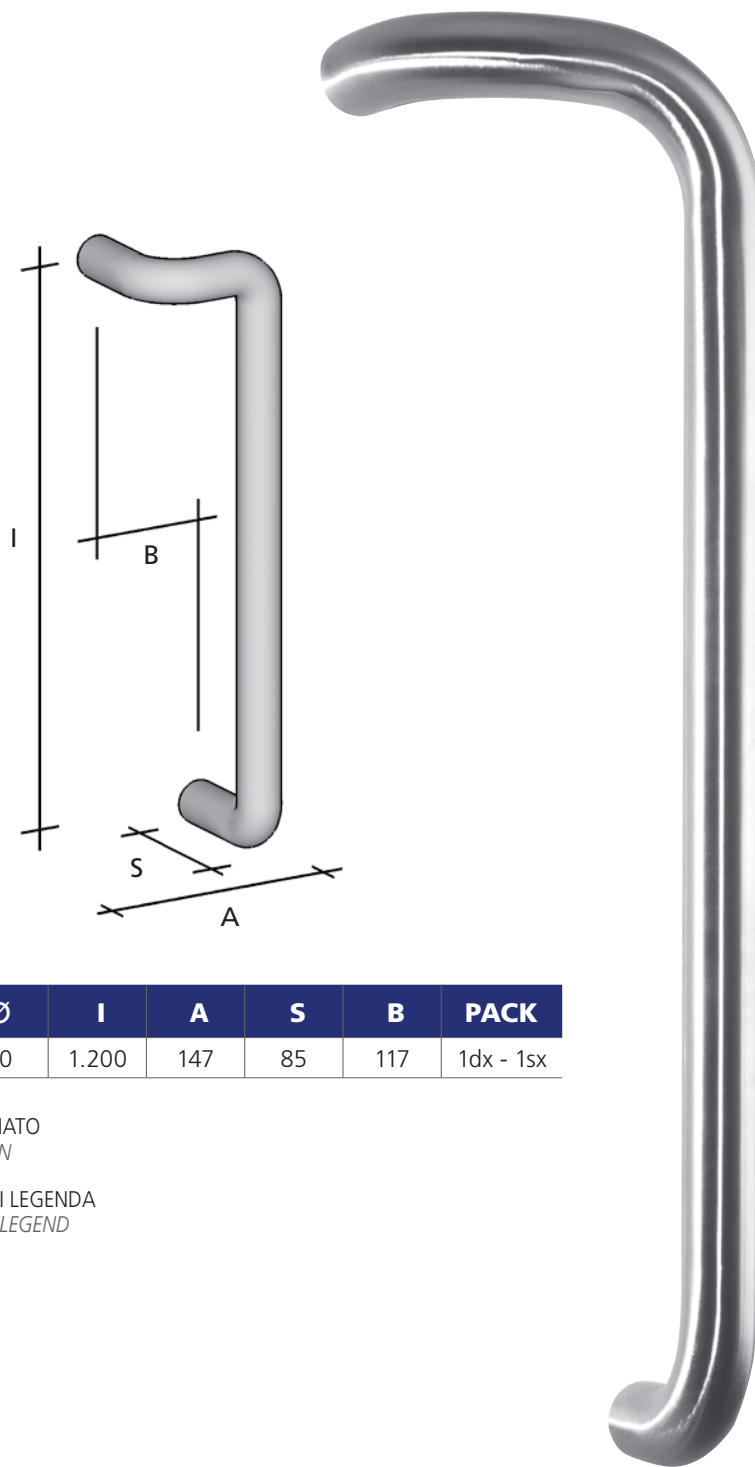

COD.	Ø	I	A	S	B	PACK
<b>05.13.302-ECO</b>	30	1.200	147	85	117	1dx - 1sx

FINITURA STANDARD: SATINATO  
STANDARD FINISHING: SATIN

FINITURA A RICHIESTA: VEDI LEGENDA  
FINISHING ON REQUEST: SEE LEGEND

Cod. **05.14-ECO**

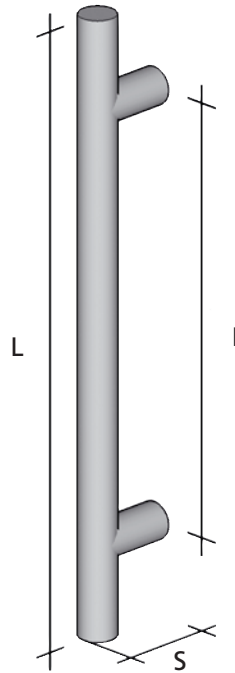

<b>COD.</b>	<b>Ø</b>	<b>I</b>	<b>S</b>	<b>L</b>	<b>PACK</b>
<b>05.14.101-ECO</b>	20	150	65	300	2
<b>05.14.102-ECO</b>	20	250	65	400	2
<b>05.14.103-ECO</b>	20	300	65	450	2
<b>05.14.104V-ECO</b>	20	D	65	D	-
<b>05.14.201-ECO</b>	25	150	70	300	2
<b>05.14.202-ECO</b>	25	250	70	400	2
<b>05.14.203-ECO</b>	25	300	70	450	2
<b>05.14.204-ECO</b>	25	350	70	500	2
<b>05.14.205V-ECO</b>	25	D	70	D	-
<b>05.14.301-ECO</b>	30	300	75	450	2
<b>05.14.302-ECO</b>	30	350	75	500	2
<b>05.14.303-ECO</b>	30	500	75	650	2
<b>05.14.304V-ECO</b>	30	D	75	D	-
<b>05.14.401-ECO</b>	35	300	80	450	2
<b>05.14.402-ECO</b>	35	350	80	500	2
<b>05.14.403-ECO</b>	35	500	80	650	2
<b>05.14.404V-ECO</b>	35	D	80	D	-

FINITURA STANDARD: SATINATO  
 STANDARD FINISHING: SATIN

FINITURA A RICHIESTA: VEDI LEGENDA  
 FINISHING ON REQUEST: SEE LEGEND

# PROGETTO 05 ECO INOX AISI 304

PROJECT 05 ECO STAINLESS STEEL AISI 304

Cod. 05.20-ECO

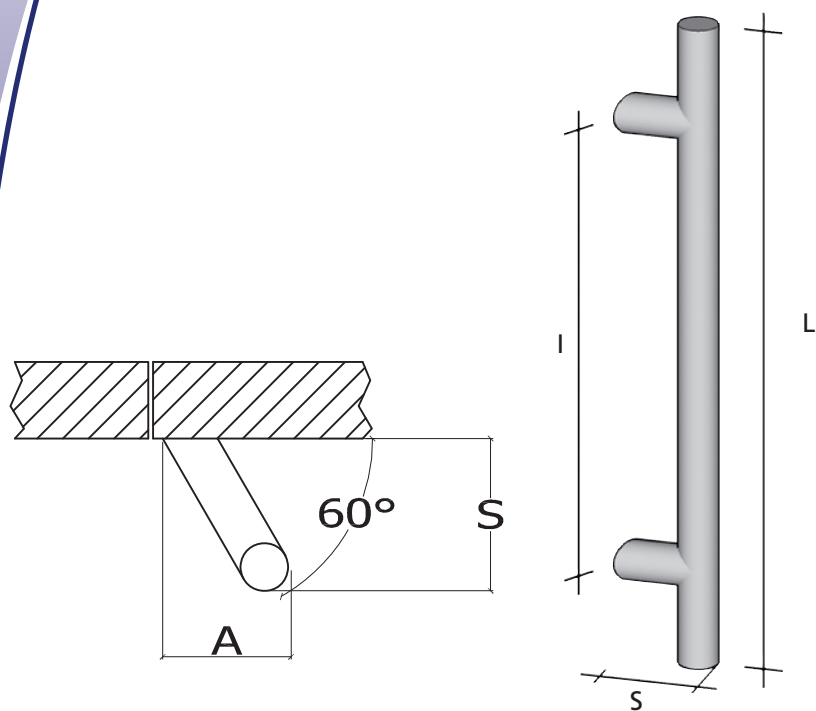

COD.	Ø	I	A	S	L	PACK
05.20.201-ECO	25	150	63	75	300	2
05.20.202-ECO	25	250	63	75	400	2
05.20.203-ECO	25	300	63	75	450	2
05.20.204-ECO	25	350	63	75	500	2
05.20.205V-ECO	25	D	63	75	D	-
05.20.301-ECO	30	300	70	80	450	2
05.20.302-ECO	30	350	70	80	500	2
05.20.303-ECO	30	500	70	80	650	2
05.20.304V-ECO	30	D	70	80	D	-
05.20.401V-ECO	35	D	75	90	D	-

FINITURA STANDARD: SATINATO  
STANDARD FINISHING: SATIN

FINITURA A RICHIESTA: VEDI LEGENDA  
FINISHING ON REQUEST: SEE LEGEND



Cod. **05.22-ECO**

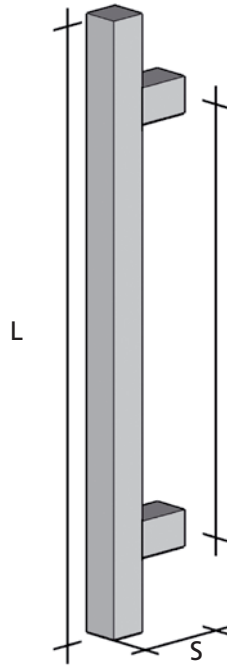

<b>COD.</b>		<b>I</b>	<b>S</b>	<b>L</b>	<b>PACK</b>
<b>05.22.201-ECO</b>	25 x 25	300	70	450	2
<b>05.22.202-ECO</b>	25 x 25	350	70	500	2
<b>05.22.203V-ECO</b>	25 x 25	D	70	D	-
<b>05.22.301-ECO</b>	30 x 30	500	75	650	2
<b>05.22.302V-ECO</b>	30 x 30	D	75	D	-
<b>05.22.401-ECO</b>	35 x 35	600	80	750	2
<b>05.22.402V-ECO</b>	35 x 35	D	80	D	-

FINITURA STANDARD: SATINATO  
 STANDARD FINISHING: SATIN

FINITURA A RICHIESTA: VEDI LEGENDA  
 FINISHING ON REQUEST: SEE LEGEND

Cod. 05.23-ECO

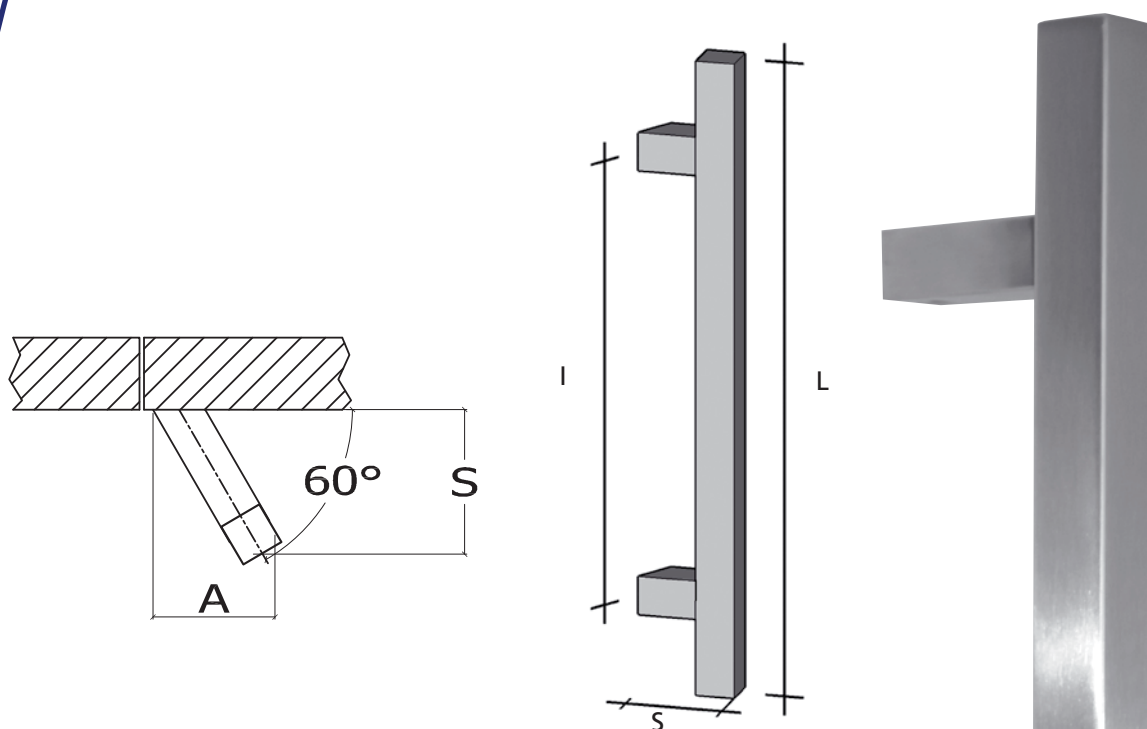

COD.		I	A	S	L	PACK
05.23.201-ECO	25 x 25	300	65	80	450	2
05.23.202-ECO	25 x 25	350	65	80	500	2
05.23.203V-ECO	25 x 25	D	65	80	D	-
05.23.301-ECO	30 x 30	350	70	85	500	2
05.23.302-ECO	30 x 30	500	70	85	650	2
05.23.303V-ECO	30 x 30	D	70	85	D	-
05.23.401V-ECO	35 x 35	D	75	85	D	-

FINITURA STANDARD: SATINATO  
 STANDARD FINISHING: SATIN

FINITURA A RICHIESTA: VEDI LEGENDA  
 FINISHING ON REQUEST: SEE LEGEND



Cod. **05.32-ECO**

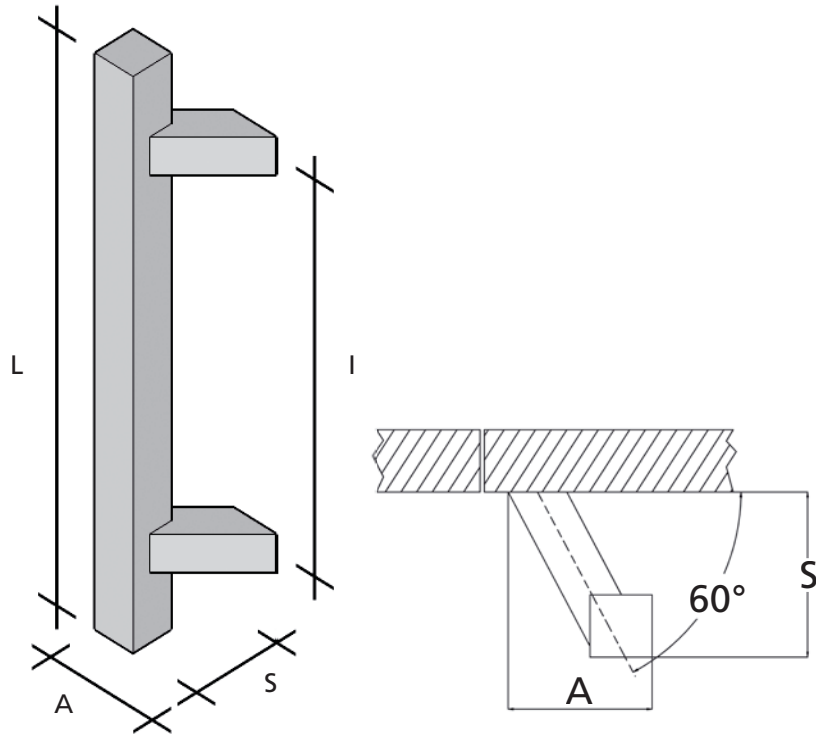

COD.		I	A	S	L	PACK
<b>05.32.201-ECO</b>	25 x 25	300	70	85	450	2
<b>05.32.202-ECO</b>	25 x 25	350	70	85	500	2
<b>05.32.203V-ECO</b>	25 x 25	D	70	85	D	-
<b>05.32.301-ECO</b>	30 x 30	350	75	90	500	2
<b>05.32.302-ECO</b>	30 x 30	500	75	90	650	2
<b>05.32.303V-ECO</b>	30 x 30	D	75	90	D	-
<b>05.32.401V-ECO</b>	35 x 35	D	80	95	D	-

FINITURA STANDARD: SATINATO  
 STANDARD FINISHING: SATIN

FINITURA A RICHIESTA: VEDI LEGENDA  
 FINISHING ON REQUEST: SEE LEGEND

# PROGETTO 05 ECO INOX AISI 304

PROJECT 05 ECO STAINLESS STEEL AISI 304

Cod. 05.19-ECO

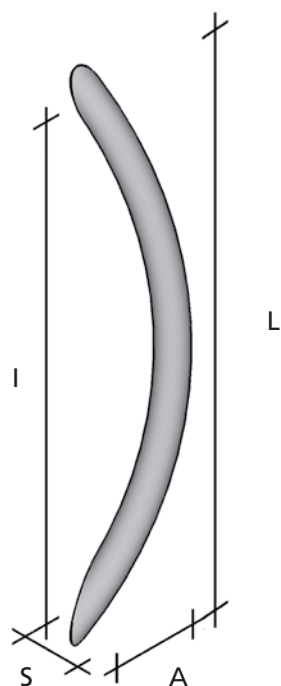

COD.	Ø	I	A	S	L	PACK
05.19.302-ECO	32	500	85	85	600	2

FINITURA STANDARD: SATINATO  
STANDARD FINISHING: SATIN

FINITURA A RICHIESTA: VEDI LEGENDA  
FINISHING ON REQUEST: SEE LEGEND

Cod. **05.21-ECO**

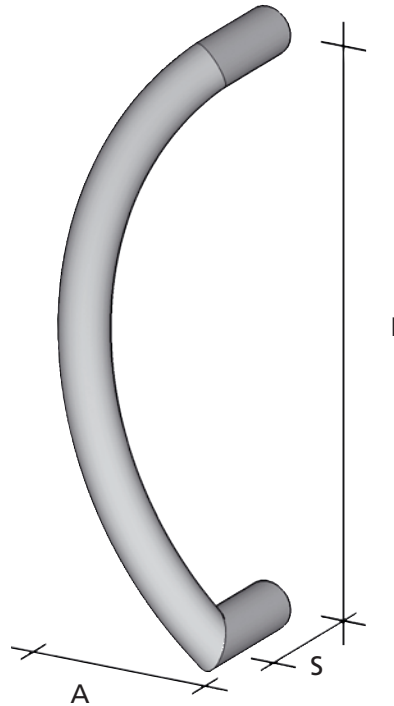

COD.	Ø	I	A	S	PACK
<b>05.21.302-ECO</b>	32	350	100	75	2

FINITURA STANDARD: SATINATO  
STANDARD FINISHING: SATIN

FINITURA A RICHIESTA: VEDI LEGENDA  
FINISHING ON REQUEST: SEE LEGEND



# PROGETTO 05 ECO INOX AISI 304

PROJECT 05 ECO STAINLESS STEEL AISI 304

Cod. 05.44-ECO

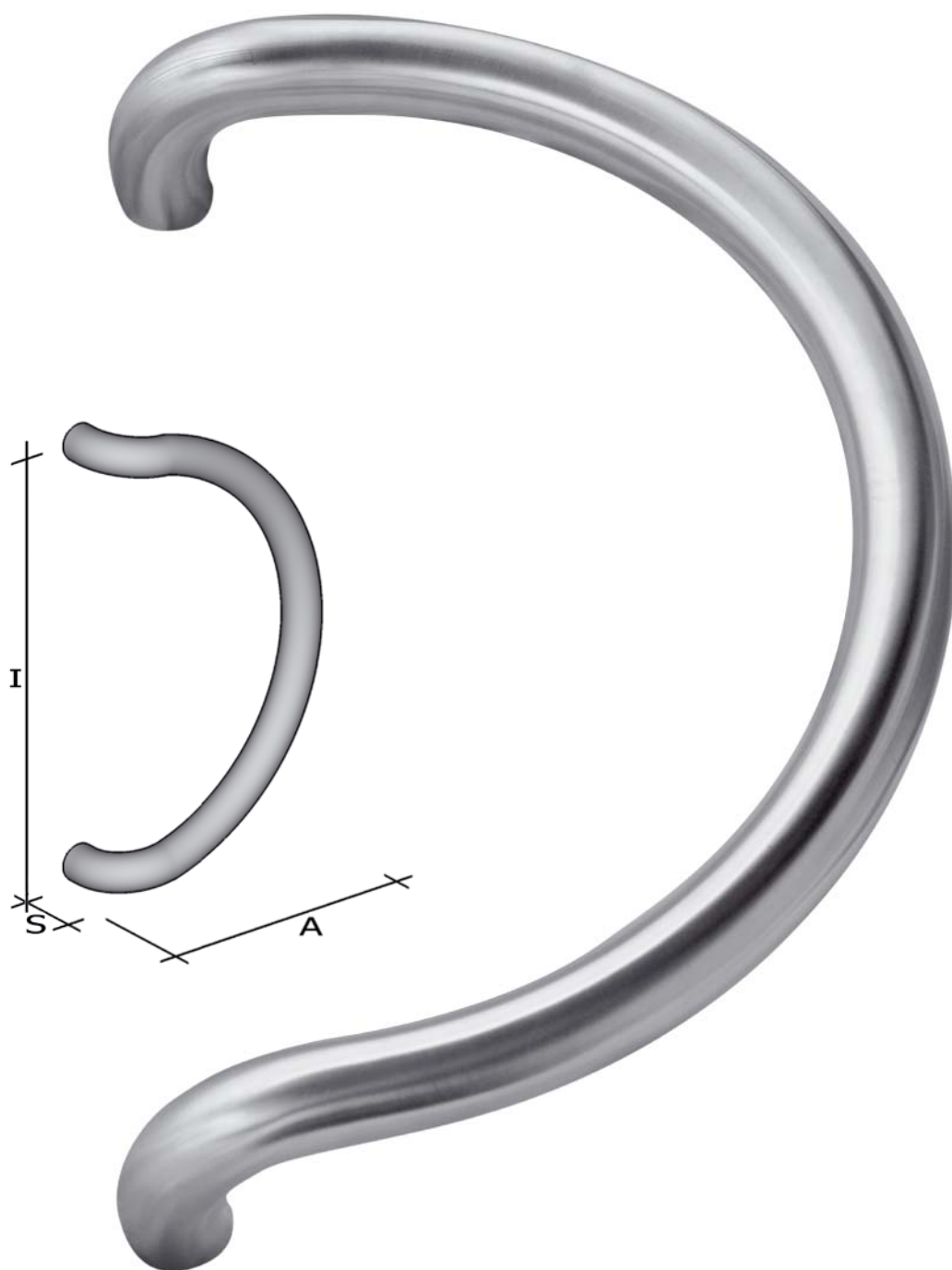

COD.	Ø	I	A	S	PACK
05.44.301-ECO	32	350	180	75	2

FINITURA STANDARD: SATINATO  
STANDARD FINISHING: SATIN

FINITURA A RICHIESTA: VEDI LEGENDA  
FINISHING ON REQUEST: SEE LEGEND

Cod. **05.25-ECO**

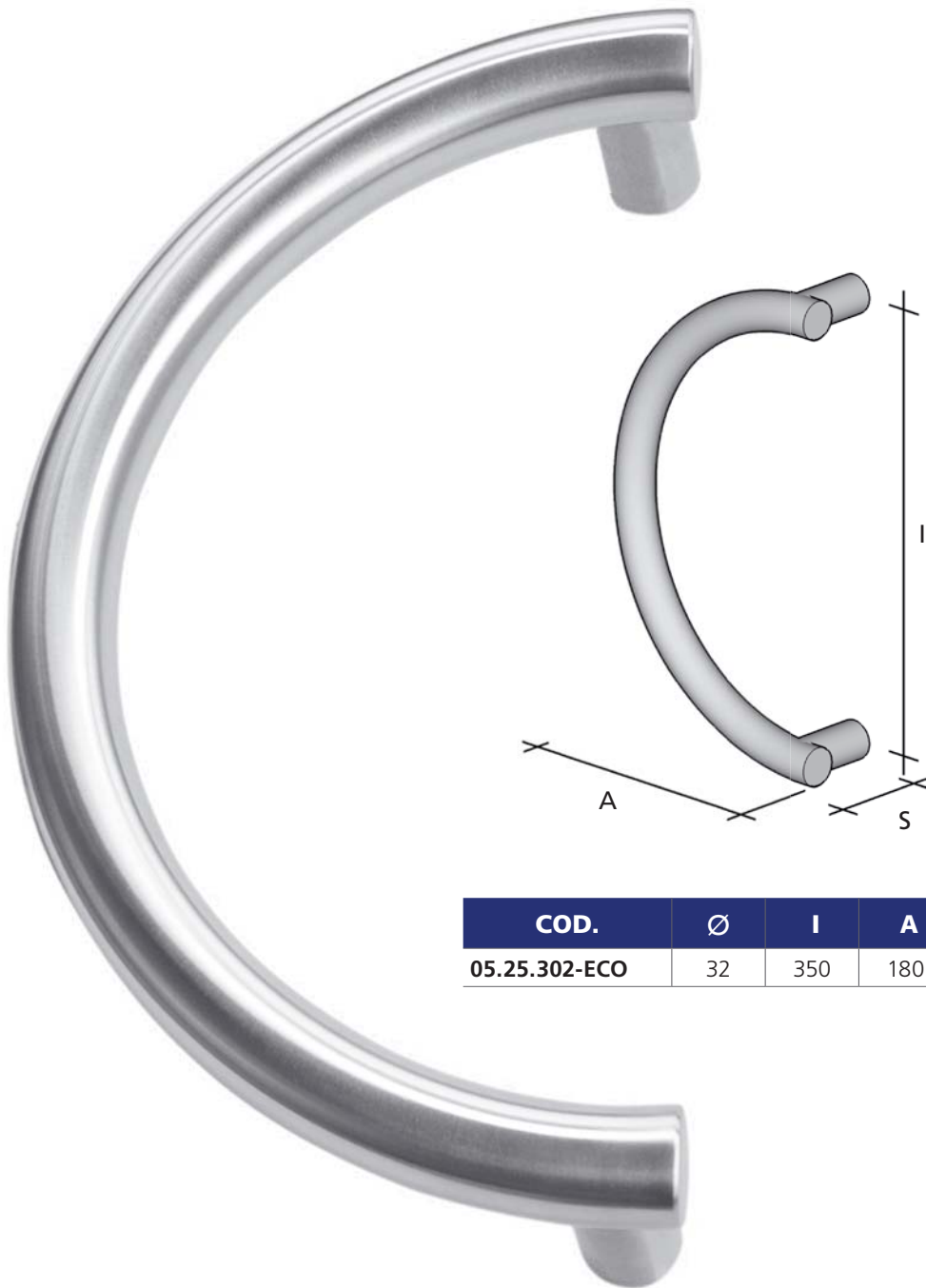



<b>COD.</b>	<b>Ø</b>	<b>I</b>	<b>A</b>	<b>S</b>	<b>PACK</b>
<b>05.25.302-ECO</b>	32	350	180	75	2

FINITURA STANDARD: SATINATO  
STANDARD FINISHING: SATIN

FINITURA A RICHIESTA: VEDI LEGENDA  
FINISHING ON REQUEST: SEE LEGEND

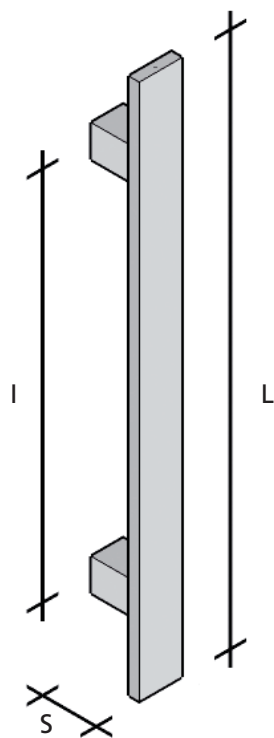
Cod. **05.36-ECO**





COD.		I	S	L	PACK
<b>05.36.511-ECO</b>	40 x 10	350	55	500	2

FINITURA STANDARD: SATINATO  
 STANDARD FINISHING: SATIN

FINITURA A RICHIESTA: VEDI LEGENDA  
 FINISHING ON REQUEST: SEE LEGEND

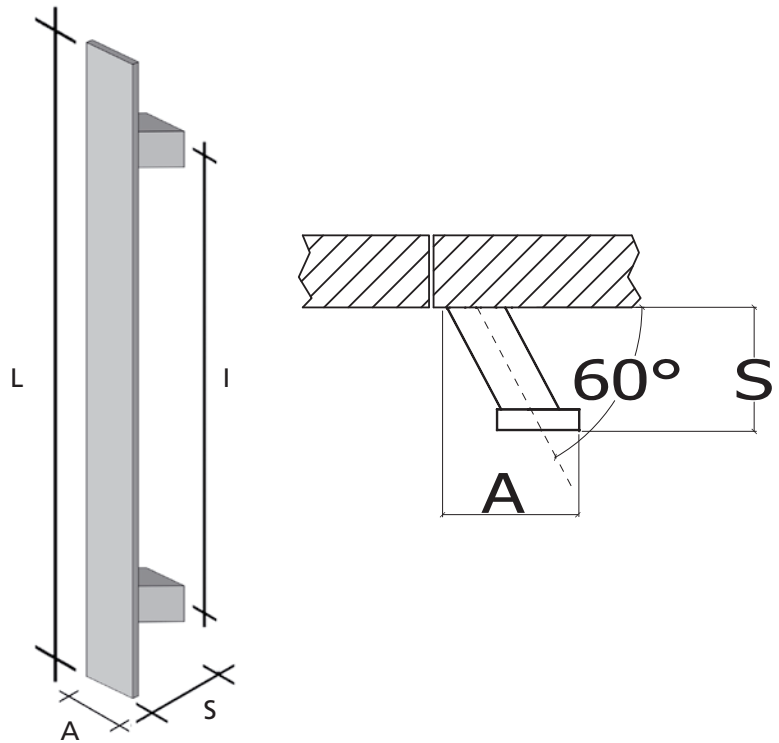
Cod. **05.43-ECO**



COD.		I	A	S	L	PACK
<b>05.43.511-ECO</b>	40 x 10	350	62	55	500	2

FINITURA STANDARD: SATINATO  
 STANDARD FINISHING: SATIN

FINITURA A RICHIESTA: VEDI LEGENDA  
 FINISHING ON REQUEST: SEE LEGEND

# PROGETTO 05 ECO INOX AISI 304

PROJECT 05 ECO STAINLESS STEEL AISI 304

Cod. 05.38-ECO

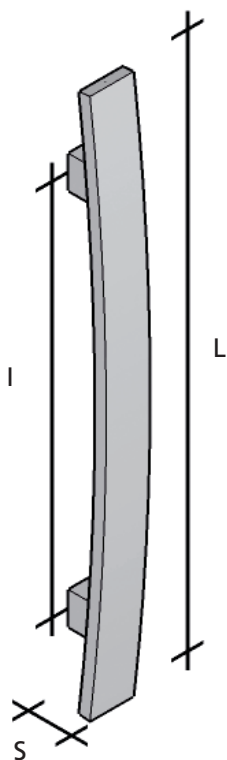

COD.		I	S	L	PACK
05.38.511-ECO	40 x 10	350	70	500	2

FINITURA STANDARD: SATINATO  
STANDARD FINISHING: SATIN

FINITURA A RICHIESTA: VEDI LEGENDA  
FINISHING ON REQUEST: SEE LEGEND

Cod. **05.26-ECO**

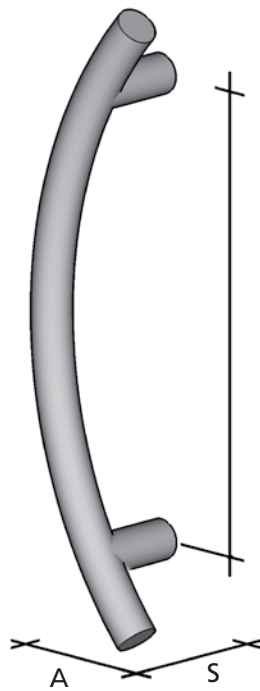

<b>COD.</b>	<b>Ø</b>	<b>I</b>	<b>A</b>	<b>S</b>	<b>PACK</b>
<b>05.26.304-ECO</b>	30	300	90	75	2
<b>05.26.305-ECO</b>	30	500	90	75	2

FINITURA STANDARD: SATINATO  
STANDARD FINISHING: SATIN

FINITURA A RICHIESTA: VEDI LEGENDA  
FINISHING ON REQUEST: SEE LEGEND

# PROGETTO 05 ECO INOX AISI 304

PROJECT 05 ECO STAINLESS STEEL AISI 304

Cod. **05.51-ECO**

Mod. **NAPOLI**

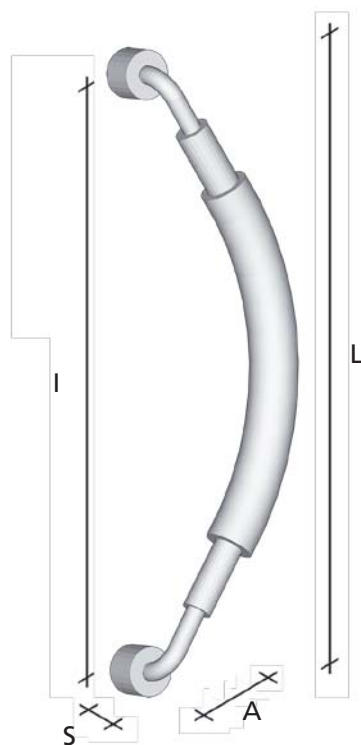

COD.	Ø	I	A	S	L	PACK
<b>05.51.301-ECO</b>	32	300	59	72	330	2
<b>05.51.302-ECO</b>	32	400	59	72	430	2
<b>05.51.303-ECO</b>	32	560	102	85	590	2

FINITURA STANDARD: SATINATO  
STANDARD FINISHING: SATIN

FINITURA A RICHIESTA: VEDI LEGENDA  
FINISHING ON REQUEST: SEE LEGEND

# PROGETTO 05 ECO INOX AISI 304

PROJECT 05 ECO STAINLESS STEEL AISI 304

Cod. 05.59-ECO



COD.	Ø	PACK
05.59.301-ECO	30	2
05.59.401-ECO	35	2
05.59.501-ECO	40	2

COD.	Ø	PACK
05.59.301DX-ECO	30	2
05.59.401DX-ECO	35	2
05.59.501DX-ECO	40	2
05.59.301SX-ECO	30	2
05.59.401SX-ECO	35	2
05.59.501SX-ECO	40	2

COD.	Ø	L (mm)
24.011.304	30 x 1,5	3.000
24.013.304	35 x 1,5	3.000
24.017.304	40 x 1,5	3.000

COD.	□	L (mm)
24.091.304	20 x 20 x 1,5	3.000
24.093.304	25 x 25 x 1,5	3.000

COD.	Descrizione Description	PACK
24.301	Schiuma poliuretanic Poliuretanic foam	1

DA USARE PER FISSARE IL RINFORZO INTERNO  
USED TO FIX THE INTERNAL SUPPORT

FINITURA STANDARD: SATINATO  
STANDARD FINISHING: SATIN



# PROGETTO 05 ECO INOX AISI 304

PROJECT 05 ECO STAINLESS STEEL AISI 304

Cod. 05.57 -ECO

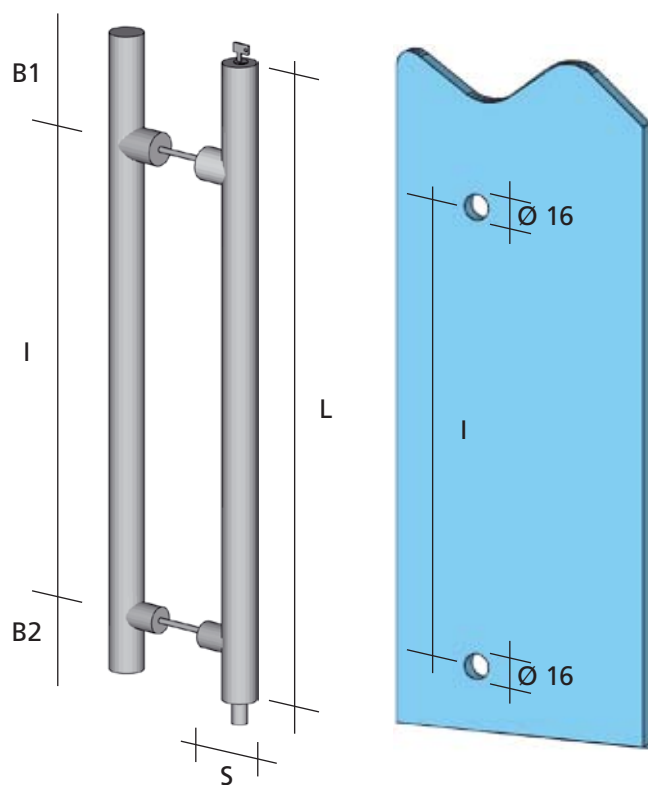

COD.	Ø	I	S	L	B1	B2	PACK
05.57.401-ECO	35	1.000	85	1.150	75	75	1



Cod. **05.58-ECO**

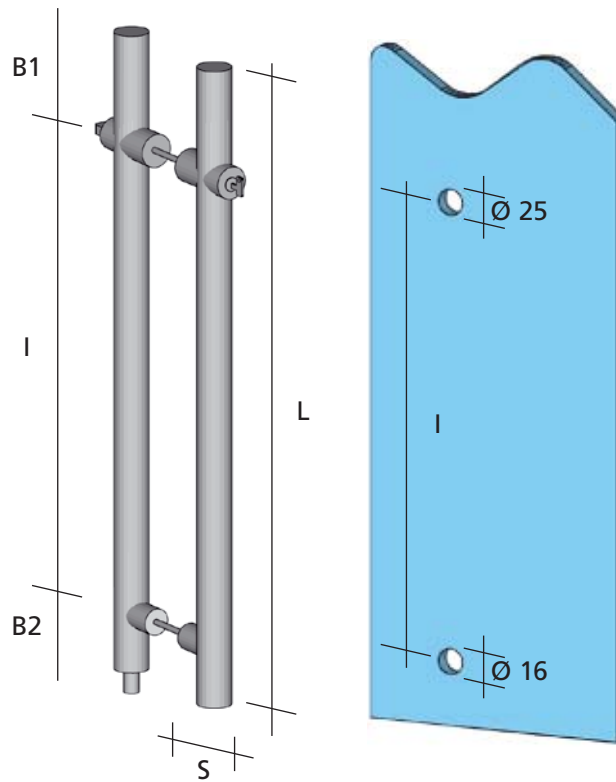

COD.	Ø	I	S	L	B1	B2	PACK
05.58.401-ECO	35	1.000	85	1.250	150	100	1

# PROGETTO 05 ECO INOX AISI 304

PROJECT 05 ECO STAINLESS STEEL AISI 304

## Cod. K.01-ECO

Fissaggio doppio su porte con profilo in alluminio, acciaio, legno e pvc  
Double fixing adaptable for aluminium, steel, wood and pvc profile

COD.	Ø	PACK	F
K.01-ECO	25 - 30 - 35	1 kit	Ø 8,5
K.01.1-ECO	20 - 	1 kit	Ø 8,5
K.01-X25-ECO*	25	1 kit	Ø 8,5
K.01-X30-ECO*	30	1 kit	Ø 8,5

\* Per maniglioni inclinati / For inclined handles

K.01

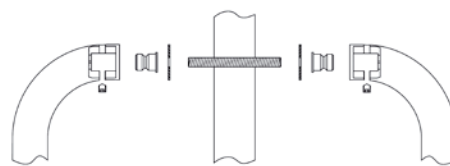

K.01-X

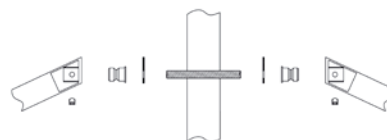

K.01-X

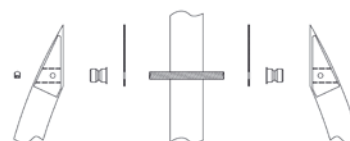

## Cod. K.02-ECO

Fissaggio doppio per porte in vetro  
Double fixing for glass doors

COD.	Ø	PACK	F
K.02-ECO	25 - 30 - 35	1 kit	Ø 14
K.02.1-ECO	20 - 	1 kit	Ø 14
K.02-X25-ECO*	25	1 kit	Ø 14
K.02-X30-ECO*	30	1 kit	Ø 14

\* Per maniglioni inclinati / For inclined handles

K.02

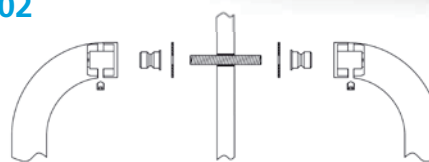

K.02-X

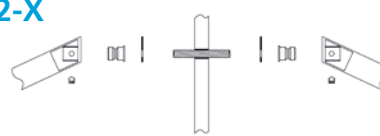

K.02-X

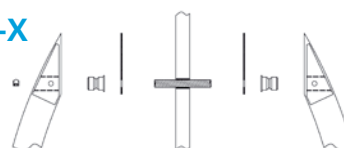

## Cod. K.03-ECO

Fissaggio singolo su profili in alluminio con fresatura  
Single fixing by means of milling for aluminium profile

COD.	Ø	PACK	F
K.03-ECO	25 - 30 - 35	1 kit	Ø 8,5
K.03.1-ECO	20 - 	1 kit	Ø 8,5
K.03-X25-ECO*	25	1 kit	Ø 8,5
K.03-X30-ECO*	30	1 kit	Ø 8,5

\* Per maniglioni inclinati / For inclined handles

K.03

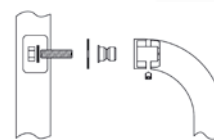

K.03-X

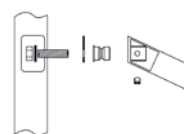

K.03-X

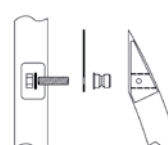

**K.03B**

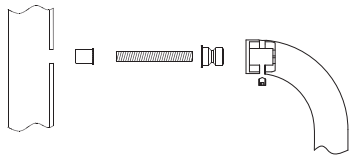

**Cod. K.03B-ECO**

Fissaggio singolo su profili in alluminio e acciaio con inserto filettato  
Single fixing on profile, with threaded insert

**K.03B-X**

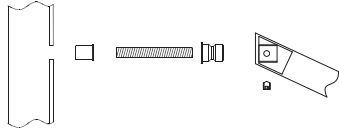

**K.03B-X**

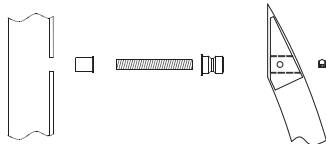

COD.	Ø	∇	PACK	F
<b>K.03B-ECO</b>	25 - 30 - 35		1 kit	Ø 11
<b>K.03B.1-ECO</b>	20 - ∅		1 kit	Ø 11
<b>K.03B-X25-ECO*</b>	25		1 kit	Ø 11
<b>K.03B-X30-ECO*</b>	30		1 kit	Ø 11

\* Per maniglioni inclinati / For inclined handles

**K.04**

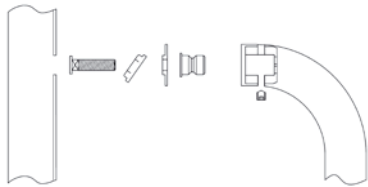

**Cod. K.04-ECO**

Fissaggio singolo per profili tubolari (sistema brevettato)  
Single fixing on profile (patent pending)

COD.	Ø	∇	PACK	F
<b>K.04.1-ECO</b>	20 - ∅		1 kit	Ø 14
<b>K.04.2-ECO</b>	25		1 kit	Ø 14
<b>K.04.3-ECO</b>	30		1 kit	Ø 14
<b>K.04.4-ECO</b>	35		1 kit	Ø 14
<b>K.04-X25-ECO*</b>	25		1 kit	Ø 14
<b>K.04-X30-ECO*</b>	30		1 kit	Ø 14

\* Per maniglioni inclinati / For inclined handles

**K.05**

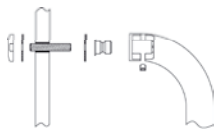

**K.05-X**



**K.05-X**

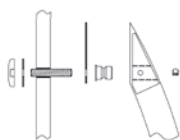

**Cod. K.05-ECO**

Fissaggio singolo per porte in vetro  
Single fixing for glass doors

COD.	Ø	∇	PACK	F
<b>K.05.1-ECO</b>	20 - ∅		1 kit	Ø 14
<b>K.05.2-ECO</b>	25		1 kit	Ø 14
<b>K.05.3-ECO</b>	30		1 kit	Ø 14
<b>K.05.4-ECO</b>	35		1 kit	Ø 14
<b>K.05-X25-ECO*</b>	25		1 kit	Ø 14
<b>K.05-X30-ECO*</b>	30		1 kit	Ø 14

\* Per maniglioni inclinati / For inclined handles

**Cod. K.06-ECO**

Fissaggio singolo con rosetta ovale in acciaio inox AISI 304 per profili tubolari, porte in legno e pvc  
Single fixing with oval Stainless Steel AISI 304 plate for profile, wooden and pvc doors

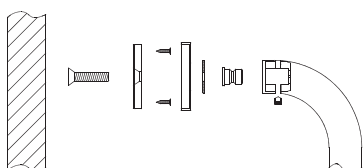

COD.	Ø	∇	PACK
<b>K.06.1-ECO</b>	20 - ∅		1 kit
<b>K.06.2-ECO</b>	25		1 kit

Finitura a richiesta: vedi legenda / Finishing on request: see legend

# PROGETTO 05 ECO INOX AISI 304

PROJECT 05 ECO STAINLESS STEEL AISI 304

## Cod. K.07-ECO

Fissaggio singolo con rosetta rettangolare in acciaio inox AISI 304 per profili tubolari, porte in legno e pvc  
Single fixing with rectangular Stainless Steel AISI 304 plate for profile, wooden and pvc doors

COD.	Ø	PACK
K.07.1-ECO	20 - 	1 kit
K.07.2-ECO	25	1 kit

Finitura a richiesta: vedi legenda / Finishing on request: see legend

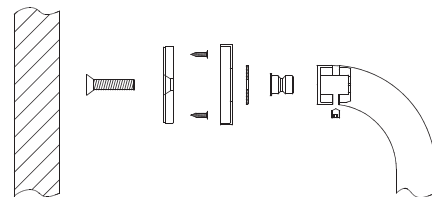

## Cod. K.09

Fissaggio singolo con rosetta tonda in acciaio inox AISI 304 per profili tubolari, porte in legno e pvc  
Single fixing with round Stainless Steel AISI 304 plate for profile, wooden and pvc doors

COD.	Ø	PACK
K.09.1-ECO	20	1 kit
K.09.2-ECO	25	1 kit
K.09.3-ECO	30	1 kit
K.09.4-ECO	35	1 kit

Finitura a richiesta: vedi legenda / Finishing on request: see legend

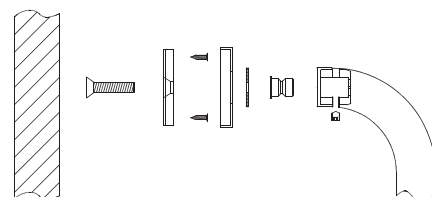

## Cod. K.10-ECO

Fissaggio singolo con rosetta quadra in acciaio inox AISI 304 per profili tubolari, porte in legno e pvc  
Single fixing with square Stainless Steel AISI 304 plate for profile, wooden and pvc doors

COD.	Ø	PACK
K.10.1-ECO	20	1 kit
K.10.2-ECO	25	1 kit
K.10.3-ECO	30	1 kit
K.10.4-ECO	35	1 kit

Finitura a richiesta: vedi legenda  
/ Finishing on request: see legend

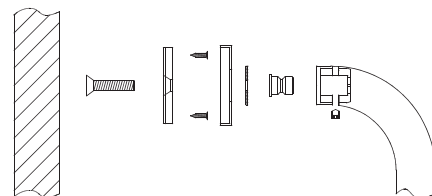

## Cod. K.11-ECO

Fissaggio singolo per porte in legno  
Single fixing for wooden doors

COD.	Ø	PACK	F
K.11-ECO	25 - 30 - 35	1 kit	Ø 4,5
K.11.1-ECO	20 - 	1 kit	Ø 4,5
K.11-X25-ECO*	25	1 kit	Ø 4,5
K.11-X30-ECO*	30	1 kit	Ø 4,5

\* Per maniglioni inclinati  
/ For inclined handles

### K.11

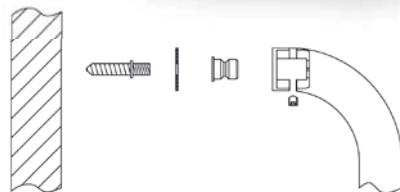

### K.11-X

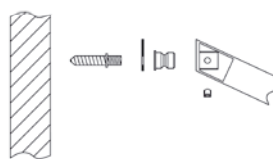

### K.11-X

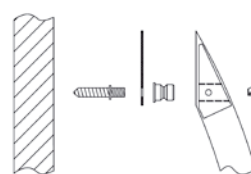

## K.13

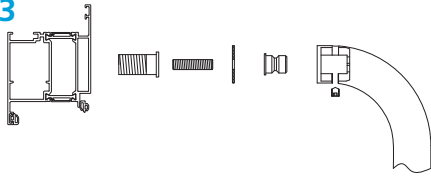

### Cod. K.13-ECO

Fissaggio singolo con vite auto-maschiante per profili a Taglio Termico  
Single fixing with auto-threaded screw for three chamber profile

## K.13-X

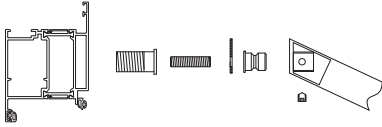

## K.13-X

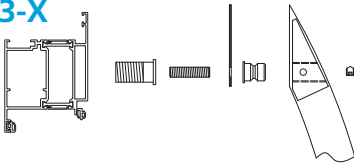

COD.	Ø	PACK	F
K.13-ECO	25 - 30 - 35	1 kit	Ø15
K.13.1-ECO	20 -	1 kit	Ø15
K.13-X25-ECO*	25	1 kit	Ø15
K.13-X30-ECO*	30	1 kit	Ø15

\* Per maniglioni inclinati / For inclined handles

## K.14

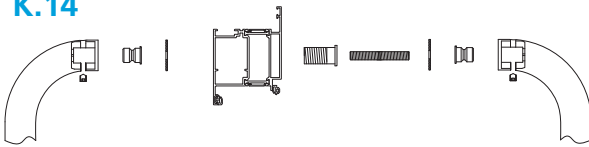

### Cod. K.14-ECO

Fissaggio doppio con vite auto-maschiante per profili a Taglio Termico  
Double fixing with auto-threaded screw for three chamber profile

## K.14-X

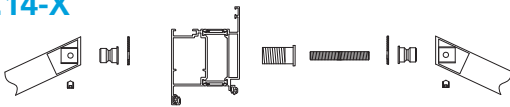

## K.14-X

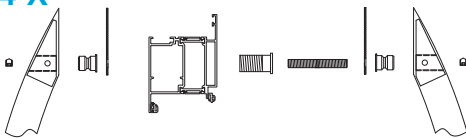

COD.	Ø	PACK	F
K.14-ECO	25 - 30 - 35	1 kit	Ø15
K.14.1-ECO	20 -	1 kit	Ø15
K.14-X25-ECO*	25	1 kit	Ø15
K.14-X30-ECO*	30	1 kit	Ø15

\* Per maniglioni inclinati / For inclined handles

## K.15

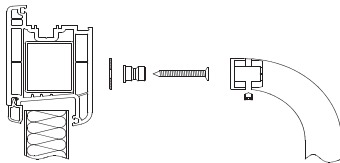

### Cod. K.15-ECO

Fissaggio singolo per profilo in pvc con vite autofilettante  
Single fixing with auto-threaded screw for pvc profile

## K.15-X

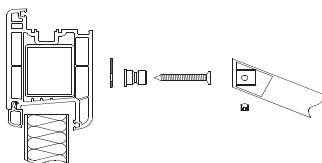

## K.15-X

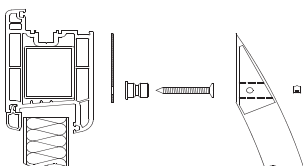

COD.	Ø	PACK
K.15-ECO	25 - 30 - 35	1 kit
K.15.1-ECO	20 -	1 kit
K.15-X25-ECO*	25	1 kit
K.15-X30-ECO*	30	1 kit

\* Per maniglioni inclinati / For inclined handles



mod. **White**  
 cod. **06.01-ECO**

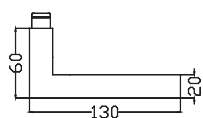

Ø 52 H 10 mm



60 x 30 H 10 mm

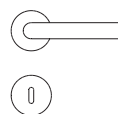

06.01.TP-ECO

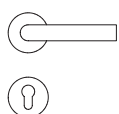

06.01.TY-ECO

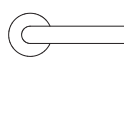

06.01.T-ECO

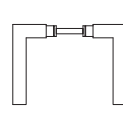

06.01.B-ECO

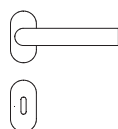

06.01.OP-ECO

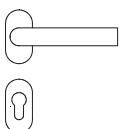

06.01.OY-ECO

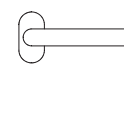

06.01.O-ECO

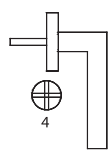

06.01.DK4-ECO

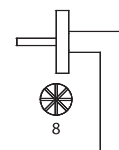

06.01.DK8-ECO

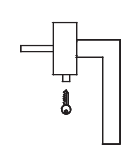

06.01.DKC-ECO

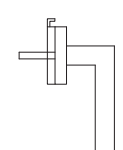

06.01.DKP-ECO



Rosetta tonda  
 Round rose



Rosetta ovale  
 Oval rose



Martellina DK  
 Window handle DK



mod. **Easy**  
 cod. **06.02-ECO**

mod. **Easy 2**  
 cod. **06.02.1-ECO**



Rosetta tonda  
 Round rose



Rosetta ovale  
 Oval rose



Martellina DK  
 Window handle DK

mod. EASY

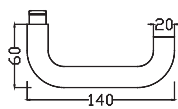

mod. EASY 2

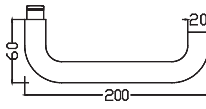

Ø 52 H 10 mm



60 x 30 H 10 mm

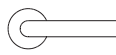

06.02.TP-ECO  
 06.02.1.TP-ECO

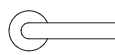

06.02.TY-ECO  
 06.02.1.TY-ECO

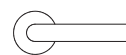

06.02.T-ECO  
 06.02.1.T-ECO

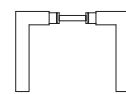

06.02.B-ECO  
 06.02.1.B-ECO

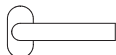

06.02.OP-ECO  
 06.02.1.OP-ECO

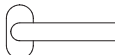

06.02.OY-ECO  
 06.02.1.OY-ECO

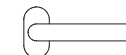

06.02.O-ECO  
 06.02.1.O-ECO

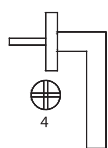

06.02.DK4-ECO  
 06.02.1.DK4-ECO

4

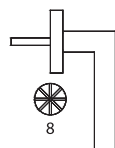

06.02.DK8-ECO  
 06.02.1.DK8-ECO

8

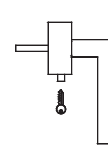

06.02.DKC-ECO  
 06.02.1.DKC-ECO

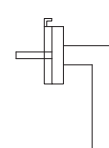

06.02.DKP-ECO  
 06.02.1.DKP-ECO



# PROGETTO 06 ECO INOX AISI 304

PROJECT 05 ECO STAINLESS STEEL AISI 304



mod. **Well**  
cod. **06.03-ECO**

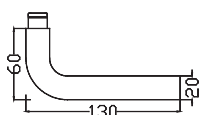

Ø 52 H 10 mm



60 x 30 H 10 mm

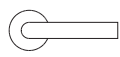

06.03.TP-ECO

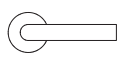

06.03.TY-ECO

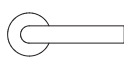

06.03.T-ECO

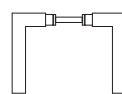

06.03.B-ECO

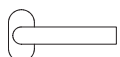

06.03.OP-ECO

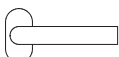

06.03.OY-ECO



06.03.O-ECO

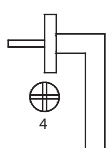

06.03.DK4-ECO

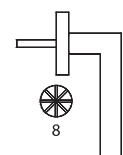

06.03.DK8-ECO

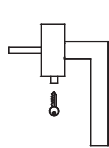

06.03.DKC-ECO

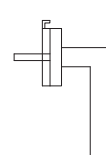

06.03.DKP-ECO



Rosetta tonda  
Round rose



Rosetta ovale  
Oval rose



Martellina DK  
Window handle DK

mod. **Manhattan**

cod. **06.04-ECO**



Rosetta tonda  
Round rose



Rosetta ovale  
Oval rose



Martellina DK  
Window handle DK

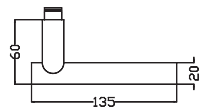

Ø 52 H 10 mm



60 x 30 H 10 mm

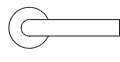

06.04.TP-ECO

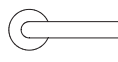

06.04.TY-ECO

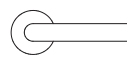

06.04.T-ECO

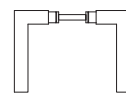

06.04.B-ECO

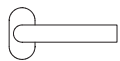

06.04.OP-ECO

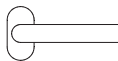

06.04.OY-ECO

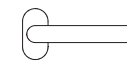

06.04.O-ECO

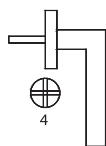

4

06.04.DK4-ECO

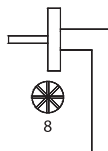

8

06.04.DK8-ECO

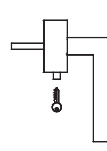

06.04.DKC-ECO

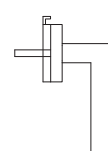

06.04.DKP-ECO



mod. **Zipper**

cod. **06.05-ECO**

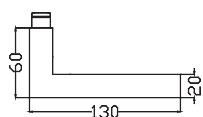

Ø 52 H 10 mm



60 x 30 H 10 mm

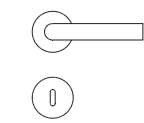

06.05.TP-ECO

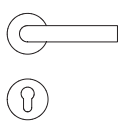

06.05.TY-ECO

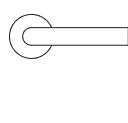

06.05.T-ECO

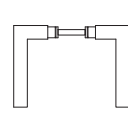

06.05.B-ECO

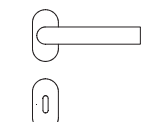

06.05.OP-ECO

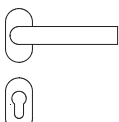

06.05.OY-ECO

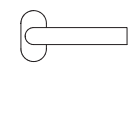

06.05.O-ECO

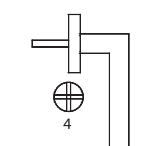

06.05.DK4-ECO

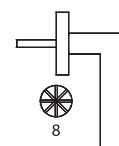

06.05.DK8-ECO

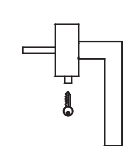

06.05.DKC-ECO

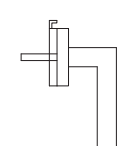

06.05.DKP-ECO



Rosetta tonda  
Round rose



Rosetta ovale  
Oval rose



Martellina DK  
Window handle DK

mod. **Sidecar**  
 cod. **06.06-ECO**



Rosetta tonda  
 Round rose



Rosetta ovale  
 Oval rose



Martellina DK  
 Window handle DK

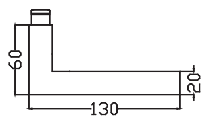

Ø 52 H 10 mm



60 x 30 H 10 mm

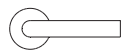

06.06.TP-ECO



06.06.TY-ECO

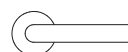

06.06.T-ECO

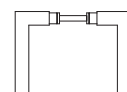

06.06.B-ECO

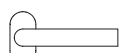

06.06.OP-ECO

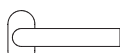

06.06.OY-ECO

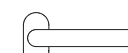

06.06.O-ECO

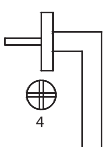

06.06.DK4-ECO

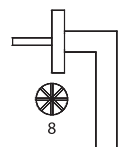

06.06.DK8-ECO

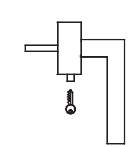

06.06.DKC-ECO

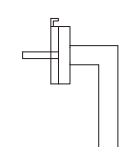

06.06.DKP-ECO

mod. **Nikita**  
 cod. **06.07-ECO**

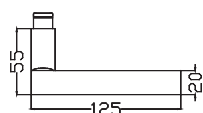

Ø 52 H 10 mm

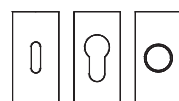

60 x 30 H 10 mm



06.07.QP-ECO



06.07.QY-ECO



06.07.Q-ECO

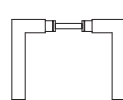

06.07.B-ECO



06.07.RP-ECO



06.07.RY-ECO



06.07.R-ECO

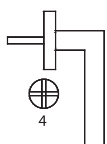

06.07.DK4-ECO

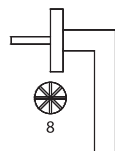

06.07.DK8-ECO

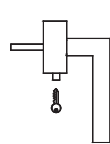

06.07.DKC-ECO

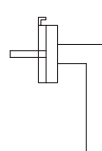

06.07.DKP-ECO



Rosetta quadra  
 Square rose



Rosetta rettangolare  
 Rectangular rose



Martellina DK  
 Window handle DK

mod. **Virgin**  
 cod. **06.08-ECO**



Rosetta quadra  
 Square rose



Rosetta rettangolare  
 Rectangular rose



Martellina DK  
 Window handle DK

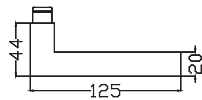

50 x 50 H 10 mm

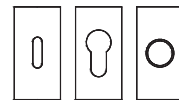
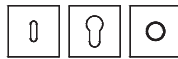

60 x 30 H 10 mm

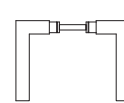
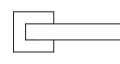
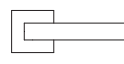
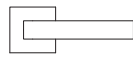

06.08.QP-ECO

06.08.QY-ECO

06.08.Q-ECO

06.08.B-ECO

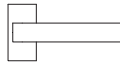
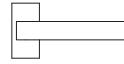
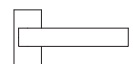

06.08.RP-ECO

06.08.RY-ECO

06.08.R-ECO

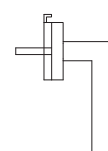
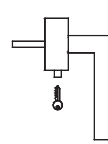
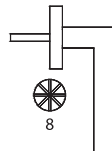
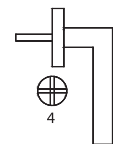

06.08.DK4-ECO

06.08.DK8-ECO

06.08.DKC-ECO

06.08.DKP-ECO

mod. **Hurricane**  
 cod. **06.09-ECO**

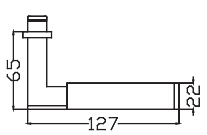

Ø 52 H 10 mm

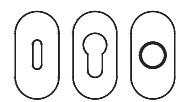

60 x 30 H 10 mm

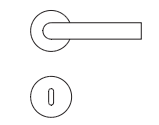

06.09.TP-ECO

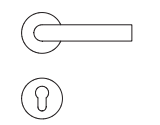

06.09.TY-ECO

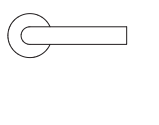

06.09.T-ECO

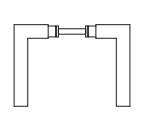

06.09.B-ECO

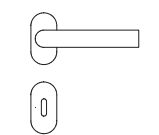

06.09.OP-ECO

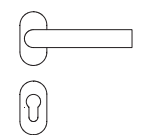

06.09.OY-ECO

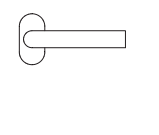

06.09.O-ECO

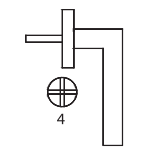

06.09.DK4-ECO

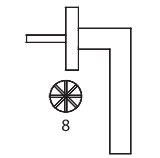

06.09.DK8-ECO

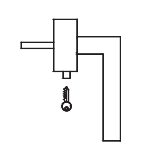

06.09.DKC-ECO

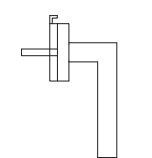

06.09.DKP-ECO

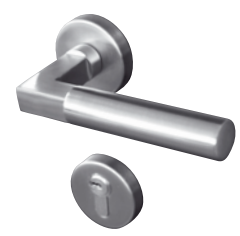

Rosetta tonda  
 Round rose



Rosetta ovale  
 Oval rose



Martellina DK  
 Window handle DK



mod. **Cosmopolitan**

cod. **06.10-ECO**



Rosetta quadra  
Square rose



Rosetta rettangolare  
Rectangular rose



Martellina DK  
Window handle DK

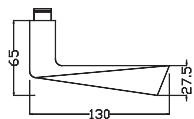

Ø 52 H 10 mm

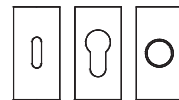

60 x 30 H 10 mm



06.10.QP-ECO

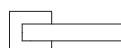

06.10.QY-ECO

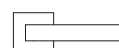

06.10.Q-ECO

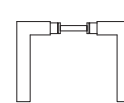

06.10.B-ECO

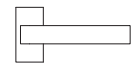

06.10.RP-ECO

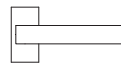

06.10.RY-ECO



06.10.R-ECO

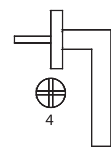

06.10.DK4-ECO

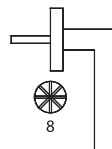

06.10.DK8-ECO

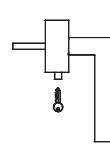

06.10.DKC-ECO

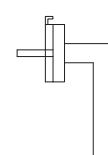

06.10.DKP-ECO





mod. **Ulisse**  
 cod. **06.11-ECO**

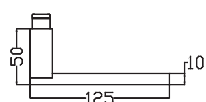

50 x 50 H 10 mm

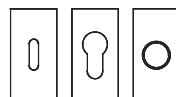

60 x 30 H 10 mm

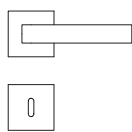

06.11.QP-ECO

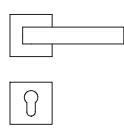

06.11.QY-ECO

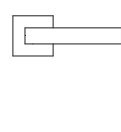

06.11.Q-ECO

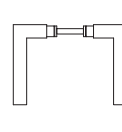

06.11.B-ECO

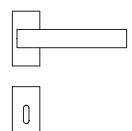

06.11.RP-ECO

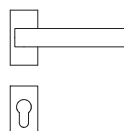

06.11.RY-ECO

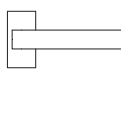

06.11.R-ECO

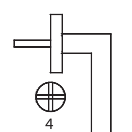

06.11.DK4-ECO

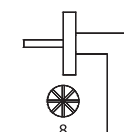

06.11.DK8-ECO

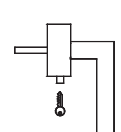

06.11.DKC-ECO

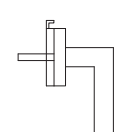

06.11.DKP-ECO



Rosetta quadra  
 Square rose



Rosetta rettangolare  
 Rectangular rose



Martellina DK  
 Window handle DK

mod. **Waikiki**  
 cod. **06.12-ECO**



Rosetta tonda  
 Round rose



Rosetta ovale  
 Oval rose



Martellina DK  
 Window handle DK

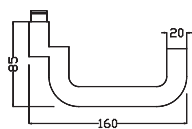

Ø 52 H 10 mm



60 x 30 H 10 mm

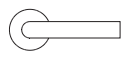

06.12.TP-ECO

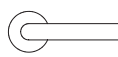

06.12.TY-ECO



06.12.T-ECO

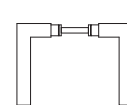

06.12.B-ECO

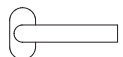

06.12.OP-ECO

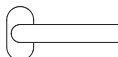

06.12.OY-ECO



06.12.O-ECO

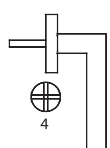

06.12.DK4-ECO

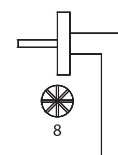

06.12.DK8-ECO

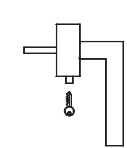

06.12.DKC-ECO

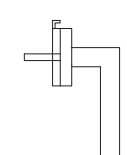

06.12.DKP-ECO

# PROGETTO 06 ECO INOX AISI 304

PROJECT 05 ECO STAINLESS STEEL AISI 304



mod. **Zaffiro**

cod. **06.13-ECO**

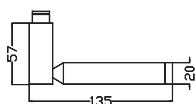

Ø 52 H 10 mm



60 x 30 H 10 mm

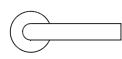

06.13.TP-ECO

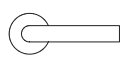

06.13.TY-ECO

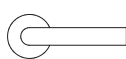

06.13.T-ECO

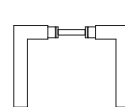

06.13.B-ECO

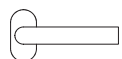

06.13.OP-ECO

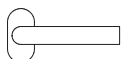

06.13.OY-ECO



06.13.O-ECO

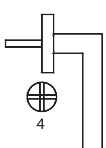

06.13.DK4-ECO

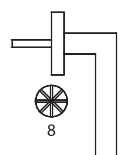

06.13.DK8-ECO

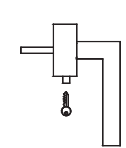

06.13.DKC-ECO

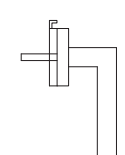

06.13.DKP-ECO



Rosetta tonda  
Round rose



Rosetta ovale  
Oval rose



Martellina DK  
Window handle DK



mod. **Acapulco**

cod. **06.14-ECO**



Rosetta tonda  
Round rose



Rosetta ovale  
Oval rose



Martellina DK  
Window handle DK

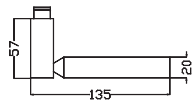

Ø 52 H 10 mm



60 x 30 H 10 mm

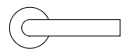

06.14.TP-ECO

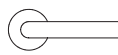

06.14.TY-ECO



06.14.T-ECO

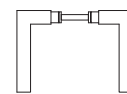

06.14.B-ECO

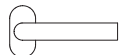

06.14.OP-ECO

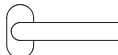

06.14.OY-ECO

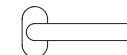

06.14.O-ECO

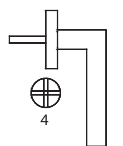

06.14.DK4-ECO

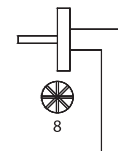

06.14.DK8-ECO

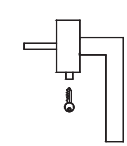

06.14.DKC-ECO

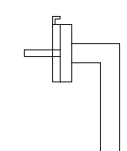

06.14.DKP-ECO



mod. **Havana**  
 cod. **06.15-ECO**

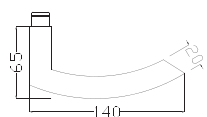

Ø 52 H 10 mm



60 x 30 H 10 mm

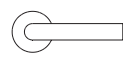

06.15.TP-ECO

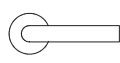

06.15.TY-ECO

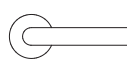

06.15.T-ECO

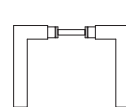

06.15.B-ECO

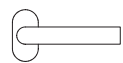

06.15.OP-ECO

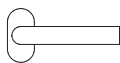

06.15.OY-ECO

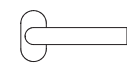

06.15.O-ECO

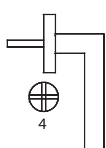

06.15.DK4-ECO

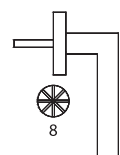

06.15.DK8-ECO

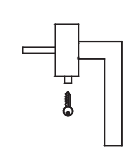

06.15.DKC-ECO

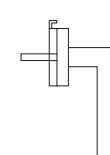

06.15.DKP-ECO



Rosetta tonda  
 Round rose



Rosetta ovale  
 Oval rose



Martellina DK  
 Window handle DK

mod. **Paradise**

cod. **06.16-ECO**



Rosetta quadra  
Square rose



Rosetta rettangolare  
Rectangular rose



Martellina DK  
Window handle DK

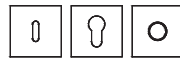
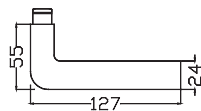

50 x 50 H 10 mm

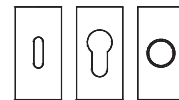

60 x 30 H 10 mm

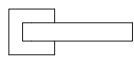

06.16.QP-ECO

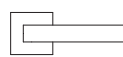

06.16.QY-ECO

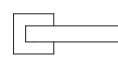

06.16.Q-ECO

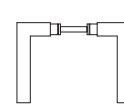

06.16.B-ECO



06.16.RP-ECO



06.16.RY-ECO

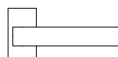

06.16.R-ECO

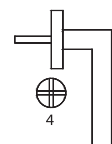

06.16.DK4-ECO

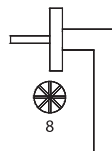

06.16.DK8-ECO

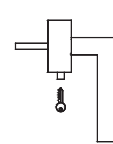

06.16.DKC-ECO

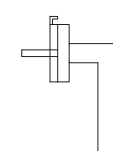

06.16.DKP-ECO



mod. **Liberty**  
 cod. **06.17-ECO**

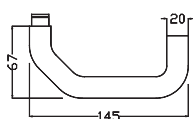

Ø 52 H 10 mm



60 x 30 H 10 mm

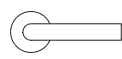

06.17.TP-ECO

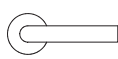

06.17.TY-ECO

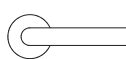

06.17.T-ECO

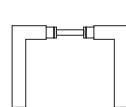

06.17.B-ECO



06.17.OP-ECO

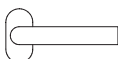

06.17.OY-ECO



06.17.O-ECO

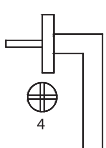

06.17.DK4-ECO

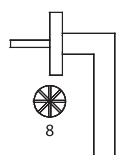

06.17.DK8-ECO

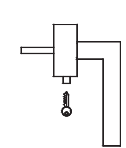

06.17.DKC-ECO

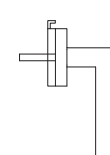

06.17.DKP-ECO



Rosetta tonda  
 Round rose



Rosetta ovale  
 Oval rose



Martellina DK  
 Window handle DK



mod. **Atlantis**  
cod. **06.18-ECO**



Rosetta tonda  
Round rose



Rosetta ovale  
Oval rose



Martellina DK  
Window handle DK

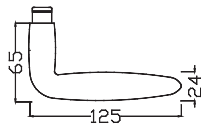

Ø 52 H 10 mm



60 x 30 H 10 mm



06.18.TP-ECO

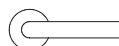

06.18.TY-ECO

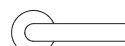

06.18.T-ECO

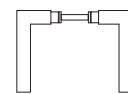

06.18.B-ECO

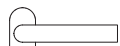

06.18.OP-ECO

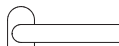

06.18.OY-ECO

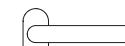

06.18.O-ECO

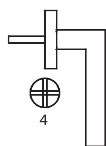

06.18.DK4-ECO

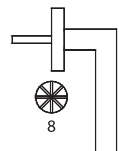

06.18.DK8-ECO

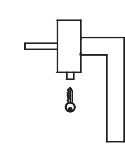

06.18.DKC-ECO

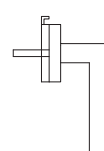

06.18.DKP-ECO





mod. **Jumbo**  
 cod. **06.19-ECO**

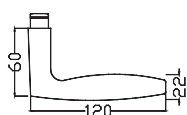

Ø 52 H 10 mm



60 x 30 H 10 mm

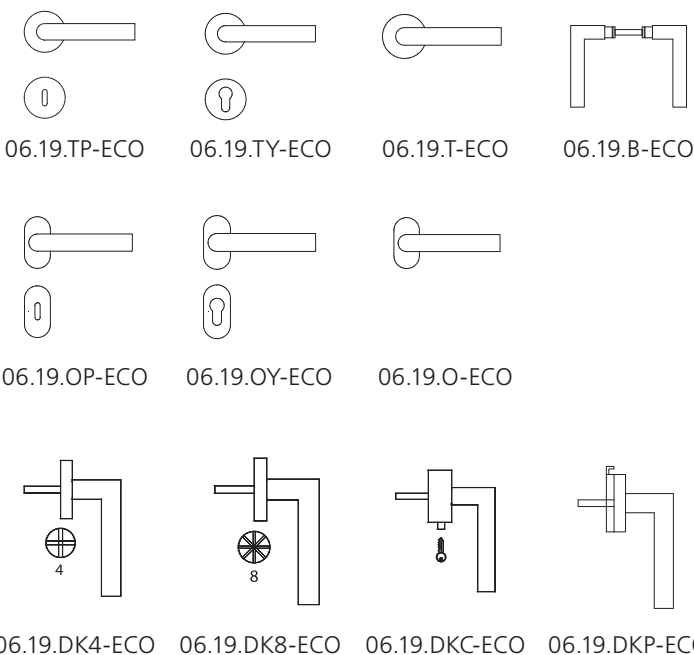

Rosetta tonda  
 Round rose



Rosetta ovale  
 Oval rose



Martellina DK  
 Window handle DK

mod. **Venus**  
 cod. **06.20-ECO**



Rosetta tonda  
 Round rose



Rosetta ovale  
 Oval rose



Martellina DK  
 Window handle DK

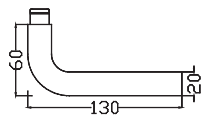

Ø 52 H 10 mm



60 x 30 H 10 mm

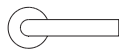

06.20.TP-ECO

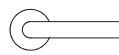

06.20.TY-ECO



06.20.T-ECO

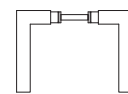

06.20.B-ECO



06.20.OP-ECO



06.20.OY-ECO



06.20.O-ECO

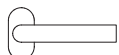

06.20.DK4-ECO

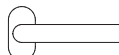

06.20.DK8-ECO

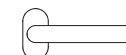

06.20.DKC-ECO



06.20.DKP-ECO

mod. **Panama**  
 cod. **06.21-ECO**



Ø 52 H 10 mm

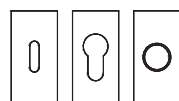

60 x 30 H 10 mm



06.21.QP-ECO

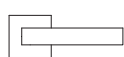

06.21.QY-ECO



06.21.Q-ECO

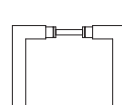

06.21.B-ECO

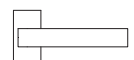

06.21.RP-ECO



06.21.RY-ECO

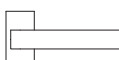

06.21.R-ECO

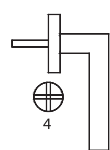

06.21.DK4-ECO

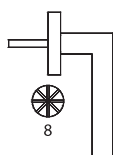

06.21.DK8-ECO

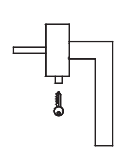

06.21.DKC-ECO

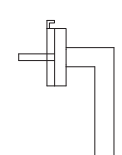

06.21.DKP-ECO



Rosetta quadra  
 Square rose



Rosetta rettangolare  
 Rectangular rose



Martellina DK  
 Window handle DK



mod. **Scorpion**  
 cod. **06.22-ECO**



Rosetta quadra  
 Square rose



Rosetta rettangolare  
 Rectangular rose



Martellina DK  
 Window handle DK

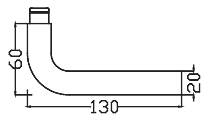

Ø 52 H 10 mm

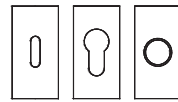

60 x 30 H 10 mm

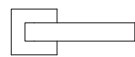

06.22.QP-ECO

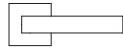

06.22.QY-ECO



06.22.Q-ECO

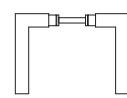

06.22.B-ECO

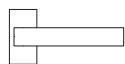

06.22.RP-ECO

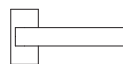

06.22.RY-ECO

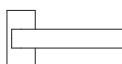

06.22.R-ECO

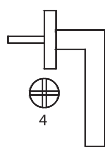

06.22.DK4-ECO

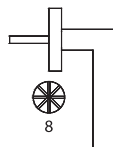

06.22.DK8-ECO

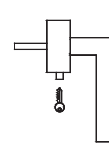

06.22.DKC-ECO

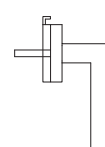

06.22.DKP-ECO



mod. **Stinger**  
 cod. **06.23-ECO**

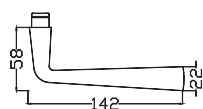

Ø 52 H 10 mm



60 x 30 H 10 mm

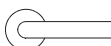

06.23.TP-ECO

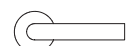

06.23.TY-ECO

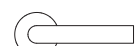

06.23.T-ECO

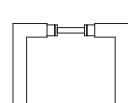

06.23.B-ECO



06.23.OP-ECO

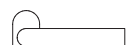

06.23.OY-ECO

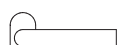

06.23.O-ECO

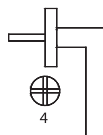

06.23.DK4-ECO

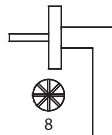

06.23.DK8-ECO

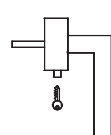

06.23.DKC-ECO

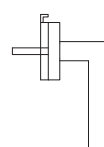

06.23.DKP-ECO



Rosetta tonda  
 Round rose



Rosetta ovale  
 Oval rose



Martellina DK  
 Window handle DK



mod. **Gibson**

cod. **06.24-ECO**



Rosetta quadra  
Square rose



Rosetta rettangolare  
Rectangular rose



Martellina DK  
Window handle DK

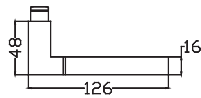

Ø 52 H 10 mm

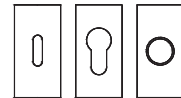

60 x 30 H 10 mm

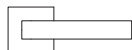

06.24.QP-ECO

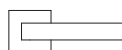

06.24.QY-ECO

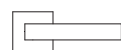

06.24.Q-ECO

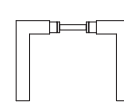

06.24.B-ECO



06.24.RP-ECO



06.24.RY-ECO



06.24.R-ECO

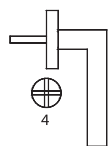

06.24.DK4-ECO

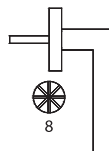

06.24.DK8-ECO

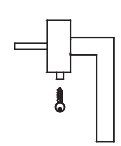

06.24.DKC-ECO

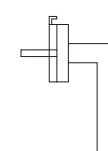

06.24.DKP-ECO

mod. **Sphere**

cod. **06.50-ECO**



Ø 52 H 10 mm



60 x 30 H 10 mm

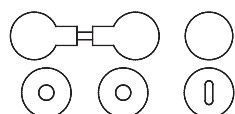
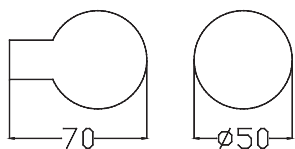

06.50.TP-ECO

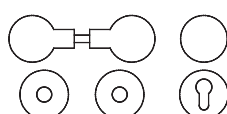

06.50.TY-ECO

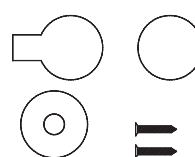

06.50.TF-ECO

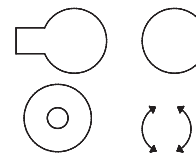

06.50.T-ECO

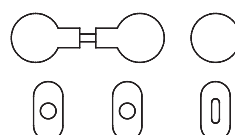

06.50.OP-ECO

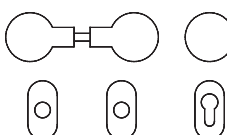

06.50.OY-ECO

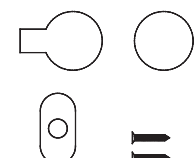

06.50.OF-ECO

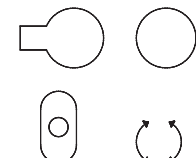

06.50.O-ECO



Ø 52 H 10 mm



60 x 30 H 10 mm

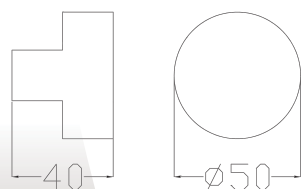

mod. **Plan**

cod. **06.51-ECO**

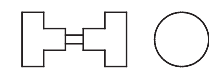

06.51.TP-ECO

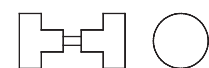

06.51.TY-ECO



06.51.TF-ECO



06.51.T-ECO



06.51.OP-ECO



06.51.OY-ECO



06.51.OF-ECO



06.51.O-ECO

mod. **Clio**

cod. **06.52-ECO**

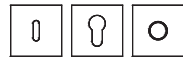

50 x 50 H 10 mm

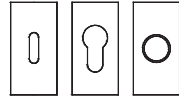

60 x 30 H 10 mm

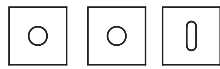
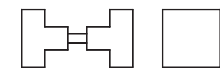
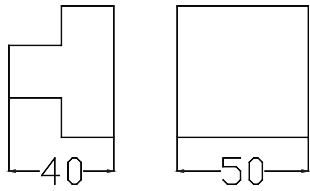

06.52.QP-ECO

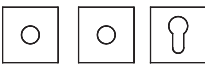
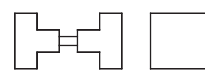

06.52.QY-ECO



06.52.QF-ECO

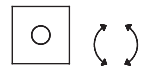

06.52.Q-ECO

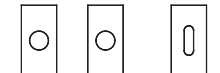
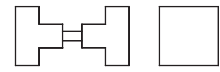

06.52.RP-ECO

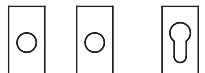
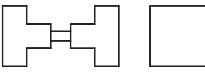

06.52.RY-ECO



06.52.RF-ECO

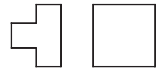

06.52.R-ECO



50 x 50 H 10 mm

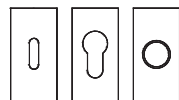

60 x 30 H 10 mm

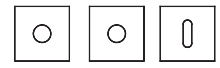
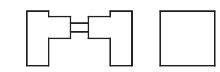
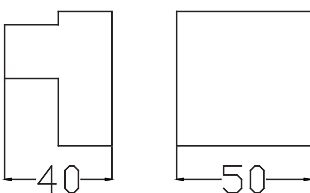

06.53.QP-ECO

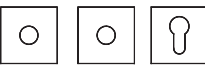
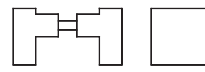

06.53.QY-ECO



06.53.QF-ECO

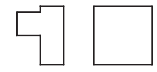

06.53.QECO

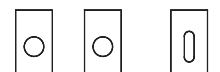
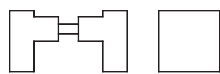

06.53.RP-ECO

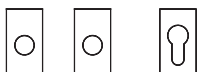
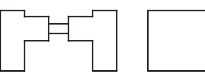

06.53.RY-ECO

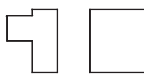

06.53.RF-ECO



06.53.R-ECO

mod. **Clio 2**

cod. **06.53-ECO**



mod. **Artemisia**

cod. **06.54-ECO**



Ø 52 H 10 mm



60 x 30 H 10 mm

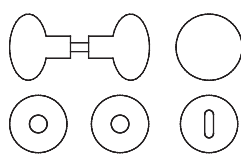

06.54.TP-ECO

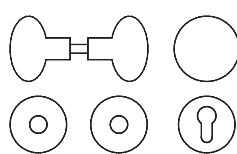

06.54.TY-ECO

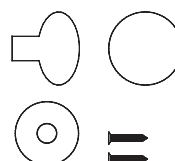

06.54.TF-ECO

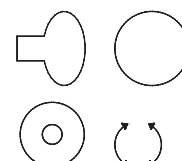

06.54.T-ECO

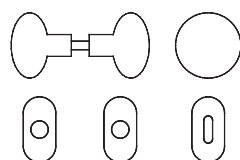
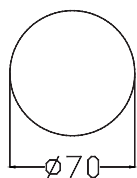
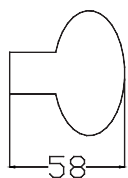

06.54.OP-ECO

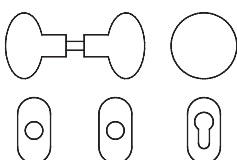

06.54.OY-ECO

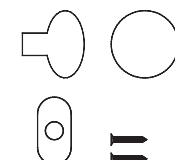

06.54.OF-ECO

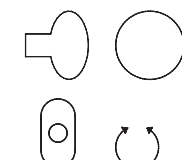

06.54.O-ECO



Ø 52 H 10 mm



60 x 30 H 10 mm

mod. **Golf**

cod. **06.55-ECO**

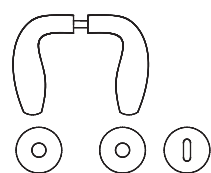

06.55.TP-ECO

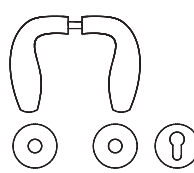

06.55.TY-ECO

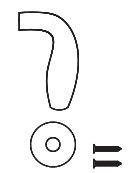

06.55.TF-ECO

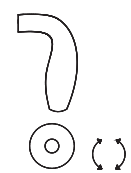

06.55.T-ECO

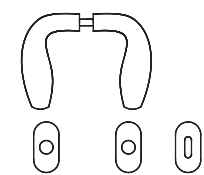
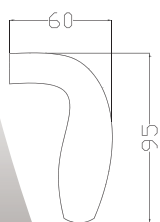

06.55.OP-ECO

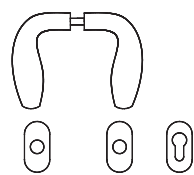

06.55.OY-ECO

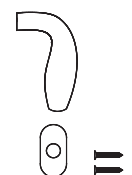

06.55.OF-ECO

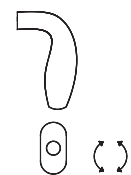

06.55.O-ECO



mod. **Sphere 2**

cod. **06.56-ECO**



Ø 52 H 10 mm

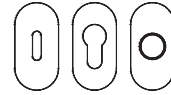

60 x 30 H 10 mm

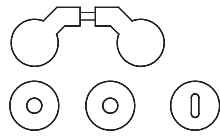

06.56.TP-ECO

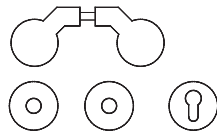

06.56.TY-ECO

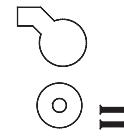

06.56.TF-ECO

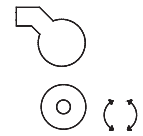

06.56.T-ECO

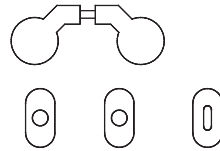
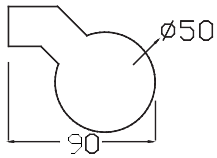

06.56.OP-ECO

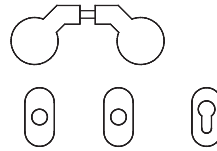

06.56.OY-ECO

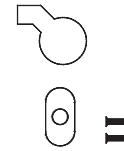

06.56.OF-ECO

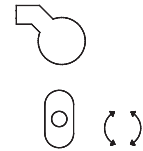

06.56.O-ECO



mod. **Fire**

cod. **06.57-ECO**

COD.	Ø	PACK
06.57.101-ECO	20	1 kit



COD.	Ø	PACK
06.57.102-ECO	20	1 kit

## ACCESSORI PER MANIGLIE E POMOLI - ACCESSORIES FOR HANDLES AND KNOBS



06.RT.A-ECO



06.BP.T-ECO



06.BY.T-ECO



06.BFO.T-ECO



06.RO.A-ECO



06.BP.O-ECO



06.BY.O-ECO



06.BFO.O-ECO



06.RQ.A-ECO



06.BP.Q-ECO



06.BY.Q-ECO



06.RR.A-ECO



06.BP.R-ECO



06.BY.R-ECO



06.BFO.R-ECO



06.CT.F-ECO



06.CQ.F-ECO



06.CO.F-ECO



06.CR.F-ECO



06.FFG-G



mod. **White**

cod. **06.AS.101-ECO**

MANIGLIONE PER ALZANTE SCORREVOLE  
PULL FOR LIFTED SLIDING DOOR

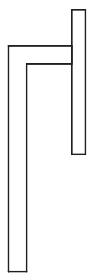
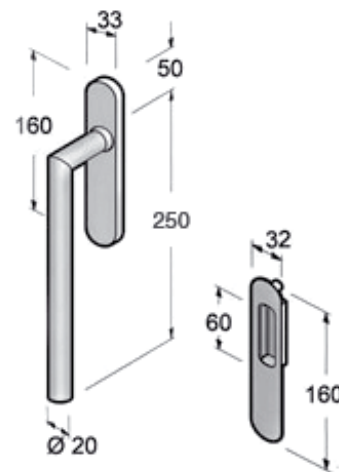

06.AS.101A-ECO



06.AS.101B-ECO

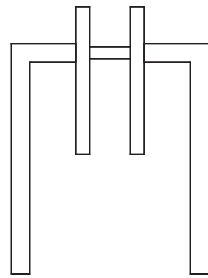

06.AS.101C-ECO

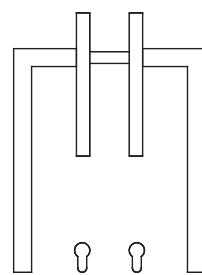

06.AS.101D-ECO



06.NAS.101-ECO



mod. **Easy**  
cod. **06.AS.102-ECO**

MANIGLIONE PER ALZANTE SCORREVOLE  
PULL FOR LIFTED SLIDING DOOR

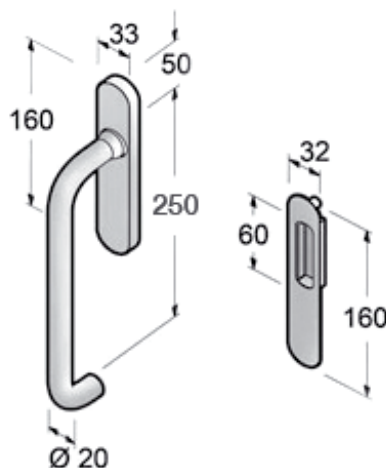

06.AS.102A-ECO

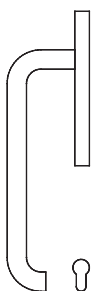

06.AS.102B-ECO

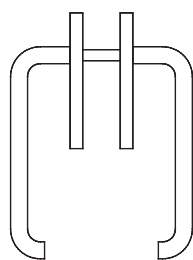

06.AS.102C-ECO

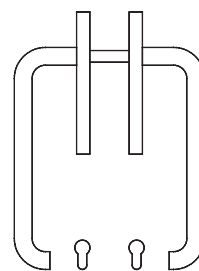

06.AS.102D-ECO



06.NAS.101-ECO

mod. **Well**

cod. **06.AS.103-ECO**



MANIGLIONE PER ALZANTE SCORREVOLE  
PULL FOR LIFTED SLIDING DOOR

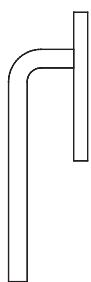
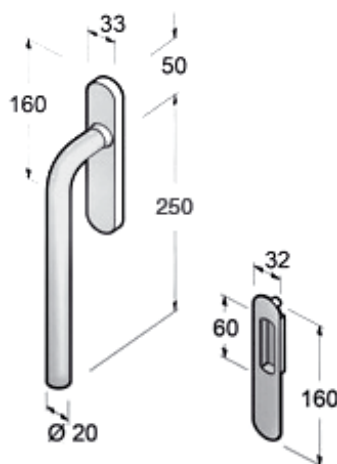

06.AS.103A-ECO

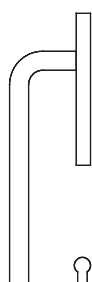

06.AS.103B-ECO

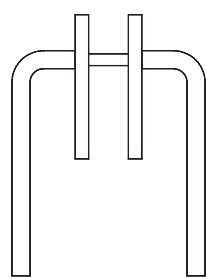

06.AS.103C-ECO

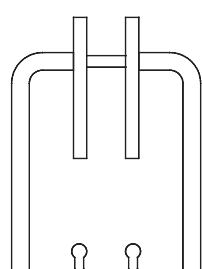

06.AS.103D-ECO



06.NAS.101-ECO

mod **Virgin**  
cod. **06.AS.104-ECO**



MANIGLIONE PER ALZANTE SCORREVOLE  
PULL FOR LIFTED SLIDING DOOR

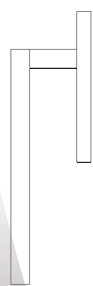
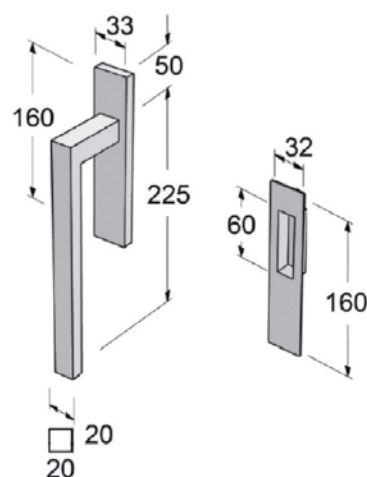

06.AS.104A-ECO



06.AS.104B-ECO

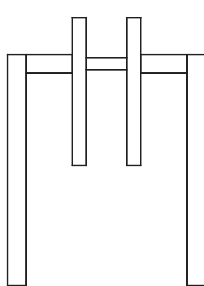

06.AS.104C-ECO

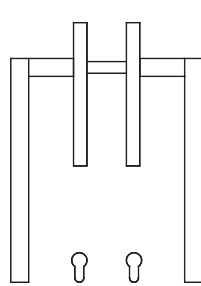

06.AS.104D-ECO



06.NAS.102-ECO

# MANIGLIONI SU MISURA - CUSTOMIZED PULL HANDLES

Ordine / Order

Richiesta d'offerta / Request of quotation

**05.14-ECO**

**05.22-ECO**

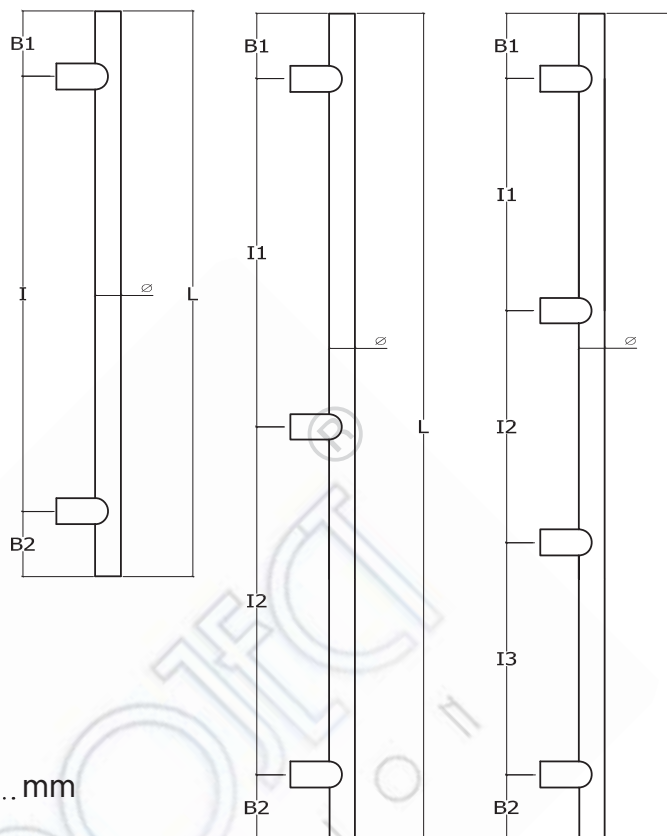

20  25  30  35

I ..... mm

B1 ..... mm

I1 ..... mm

B2 ..... mm

I2 ..... mm

S ..... mm

I3 ..... mm

L ..... mm

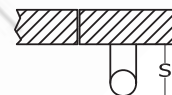

## FINITURA - FINISHING



SATINATO - SATIN



LUCIDO - POLISH



A RICHIESTA - ON REQUEST

PZ:.....	FIX: ..... (pag. 26-29)
----------	-------------------------

Azienda - Company \_\_\_\_\_

Via/Piazza - Street/Square \_\_\_\_\_

CAP \_\_\_\_\_ Città - City \_\_\_\_\_ Prov. \_\_\_\_\_ Stato - Country \_\_\_\_\_

Persona di riferimento - Reference person: \_\_\_\_\_

Cognome - Surname \_\_\_\_\_ Nome - Name \_\_\_\_\_

Tel. - Phone \_\_\_\_\_ Cell. - Mobile \_\_\_\_\_ Fax. \_\_\_\_\_

e-mail \_\_\_\_\_ web site \_\_\_\_\_



# MANIGLIONI SU MISURA - CUSTOMIZED PULL HANDLES

Ordine / Order

Richiesta d'offerta / Request of quotation

**05.20-ECO**

**05.23-ECO**

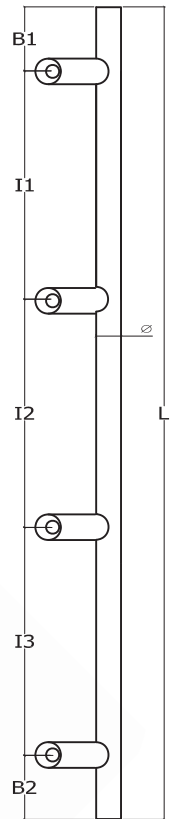
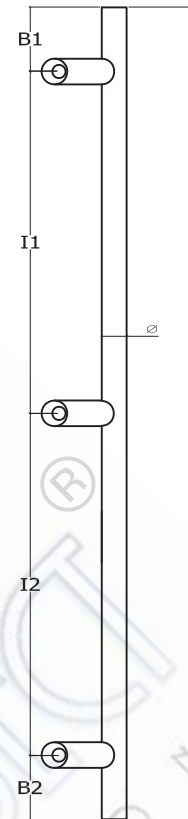
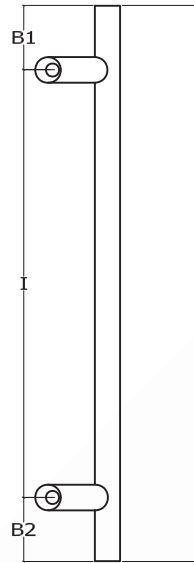
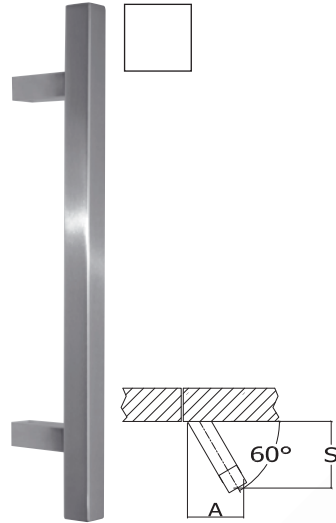

25

30

35

I ..... mm

B1 ..... mm

I1 ..... mm

B2 ..... mm

I2 ..... mm

A ..... mm

I3 ..... mm

S ..... mm

L ..... mm

## FINITURA - FINISHING



SATINATO - SATIN



LUCIDO - POLISH



.....  
A RICHIESTA - ON REQUEST

PZ:.....

FIX:..... (pag. 26-29)

Azienda - Company .....

Via/Piazza - Street/Square .....

CAP ..... Città - City ..... Prov. .... Stato - Country .....

Persona di riferimento - Reference person: .....

Cognome - Surname ..... Nome - Name .....

Tel. - Phone ..... Cell. - Mobile ..... Fax. ....

e-mail ..... web site .....

## Finiture / Finishings

**S** \_ Satinato / *Satin*

**L** \_ Lucido / *Polish*

**C** \_ Corten / *Weathering Steels*

**P** \_ Verniciato RAL / *RAL painted*

**E** \_ Legno / *Wood*

## Quote / Dimensions

**D** \_ A Richiesta / *On Request*

$\emptyset$  \_ Diametro / *Diameter*

 \_ Profilo Quadro / *Square Profile*

 \_ Profilo Ovale / *Oval Profile*

 \_ Profilo Rettangolare / *Rectangular Profile*

**I** \_ Interasse / *Axle Space*

**A** \_ Spostamento Laterale / *Lateral Displacement*

**S** \_ Profondità / *Deepness*

**L** \_ Lunghezza / *Length*

**F** \_ Foro da eseguire / *Hole to do*

## Varianti maniglie / Handles variants

**T** \_ Tonda / *Round*

**Q** \_ Quadra / *Square*

**O** \_ Ovale / *Oval*

**R** \_ Rettangolare / *Rectangular*

**M** \_ Micro / *Micro*

 **Y** \_ Foro Sagomato / *European Cylinder*

 **P** \_ Foro Chiave / *Oval Cylinder*

**B** \_ Bilancino / *Pair Handle*

 \_ Fisso / *Fixed*

 \_ Girevole / *Turning*

 **DK4** \_ DK a 4 scatti / *DK with 4 positions*

 **DK8** \_ DK a 8 scatti / *DK with 8 positions*

**DKP** \_ DK con pulsante / *DK with button*

**DKC** \_ DK con chiave / *DK with key*



info@ecoproject.one  
www.ecoproject.one

*Distributore esclusivo / Exclusive distributor:*

**MPM srl**

Via Don Domenico Valente, 14  
35013 CITTADELLA – PD Italy

Phone: +39 049 9445744 – Fax +39 049 9449438

www.mpm-inox.com – info@mpm-inox.com

www.mpm.srl – info@mpm.srl